



# WINDOWS & DOORS

HIGHLIGHTS OF ARCHITECTURE

**Internorm**<sup>®</sup>  
Windows – Doors



**3<sup>RD</sup> GENERATION** (f.l.t.r)  
 Mag. Christian Klinger BSc  
 Mag. Anette Klinger  
 DI (FH) Stephan Kubinger, MBA

## EUROPE'S NO. 1 WINDOW BRAND

Internorm has been a family business for 91 years, having developed from a one-man blacksmith's shop to the largest internationally active window brand.

During this time we have manufactured over 27 million window and door units, all 100% made in our production facilities in Traun, Sarleinsbach and Lannach in Austria. From the creation of the UPVC window and the production of the timber-aluminium window to today's high-tech and ultra-modern design innovations, our family company has been setting standards all across Europe. We are pioneers in our field and continue to further develop technology and innovative ideas.

Our 1974-strong European work force are specialists, who thrive on attention to detail and act with passion and integrity. Together with more than 1300 distribution partners in 21 countries we guarantee perfect product quality and the highest levels of service.

- Internorm manufacturing sites (production exclusively in Austria)
- Internorm offices
- Internorm distribution partners



*Make your dream*  
 HOME A REALITY.

# CONTENTS

<b>Design styles</b>	4
<b>Window and door overview</b>	6

<b>WINDOWS &amp; TECHNOLOGY</b>	<b>10</b>
uPVC & uPVC-Aluminium	12
uPVC-Aluminium window with integrated Blind	18
Timber-Aluminium	22
Timber-Aluminium window with integrated Blind	25

<b>Overview of doors</b>	26
Series F	28
Series V	30
Series P	32
Series D	34
Series G	36
Series A	38
Series S	40

<b>I-TEC INNOVATIONS</b>	<b>44</b>
I-tec Secure	46
I-tec Core	47
I-tec Ventilation	48
I-tec Shading	49
I-tec Glazing, I-tec Insulation	50
I-tec Connect	51

<b>XL GLAZINGS</b>	<b>52</b>
KS 430	54
HS 330	55
HX 300	57

<b>TIPS</b>	<b>58</b>
Perfect Combination	60
Security	62
Window handles	64
Door handles	66
Colours	68
ECLAZ®	70
Sun and insect protection	72
Juliet balcony	74
Side entrance doors	76
Warranties	78

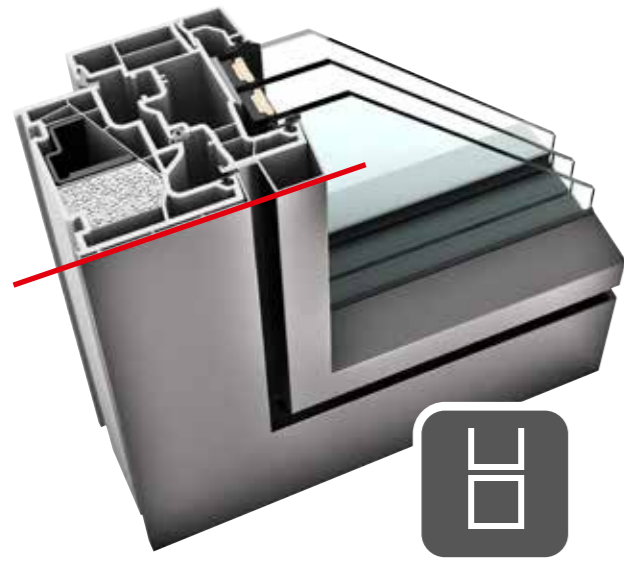

## studio

The **studio** design style is characterised by clean lines and a minimalist design. The windows become a design feature in their own right, whilst enhancing exceptional architecture.

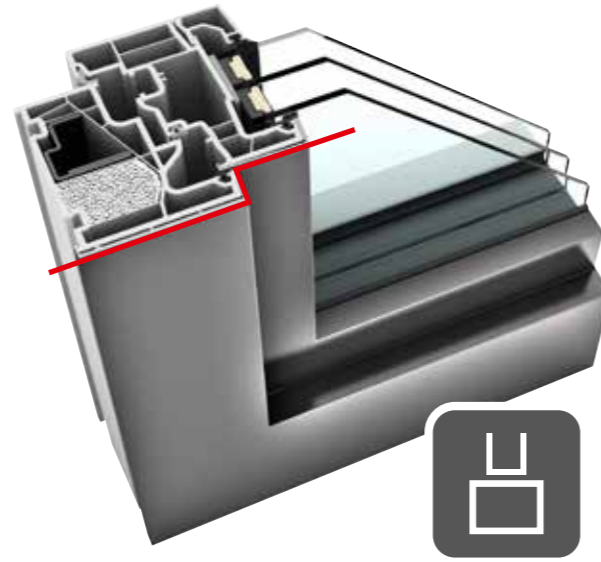

## home pure

The modern **home pure** window with its square edge design perfectly blends into the unique architecture of contemporary buildings.

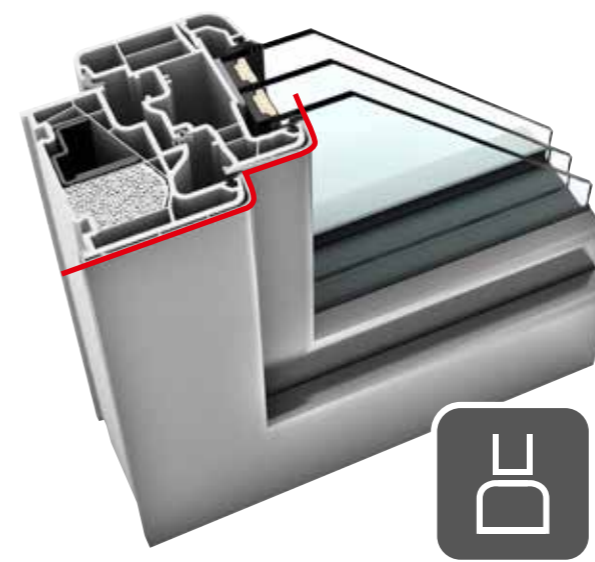

## home soft

The elegant round edge design of a **home soft** window creates a timeless look that can be integrated effortlessly into any design and architecture.

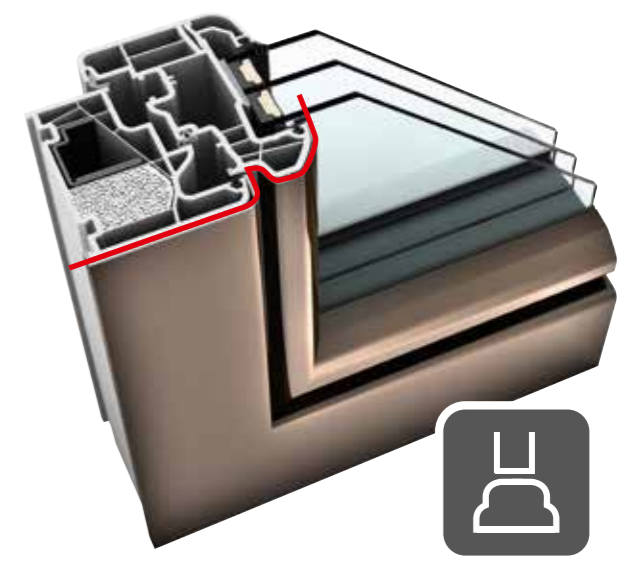

## ambiente

An **ambiente** window offers the perfect blend of traditional design and classic detailing. The round profiled edges add a special charm to any façade.



UPVC

UPVC-ALUMINIUM

studio

home pure

home soft

ambiente

studio

home pure

home soft

ambiente

**KF 310**

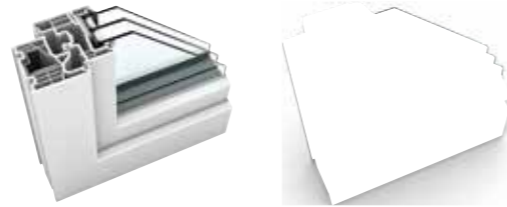

**KF 310**

**KF 320**



**KF 320**

**KF 410**



**KF 410**

**KF 510**



**KF 510**

**KF 520**



**KF 520**

**KV 350**



**KV 350**

**KV 440**



**KV 440**

TIMBER-ALUMINIUM

studio

home pure

home soft

ambiente

HF 310

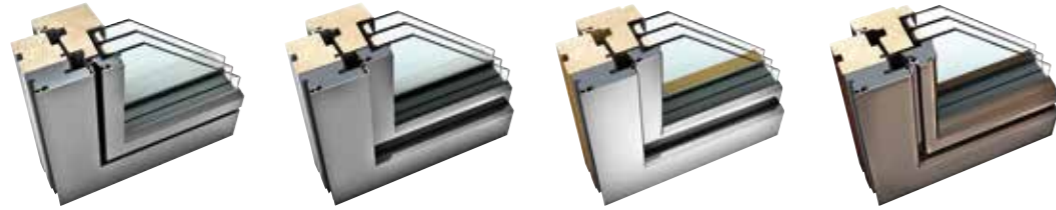

HF 410

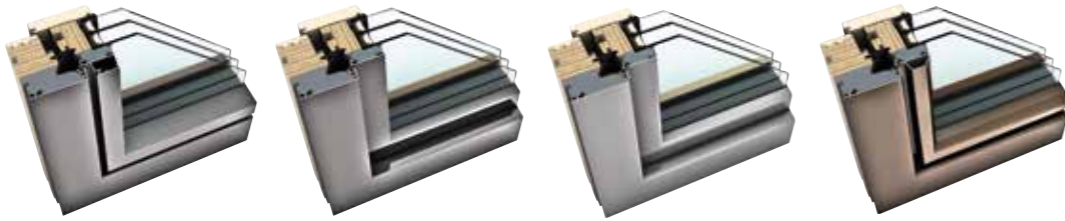

HF 510

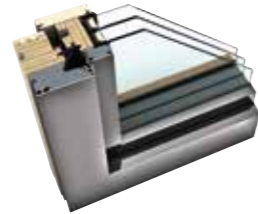

HV 450



*The bespoke window solution allows light to flood the home, creating a bright, modern and homely ambience.*





# WINDOWS & TECHNOLOGY

DESIGN AND TECHNOLOGY –  
INTERNORM PRODUCTS IN  
PERFECT HARMONY



All our high quality windows are totally bespoke and made to your exact specifications. Internorm products offer enhanced security, exceptional thermal performance and superior noise insulation.

Whatever new windows you are looking for, Internorm's design styles and product range, from frameless and contemporary to the more traditional, there is a product to suit any taste or architectural style.





# KF 310

UPVC & UPVC-ALUMINIUM WINDOW



**I-tec Glazing**

home pure

-  **Thermal insulation**  $U_w$  as low as 0.69 W/(m<sup>2</sup>K)
-  **Noise reduction** up to 45 dB
-  **Security** up to RC1N, RC2
-  **Locking** concealed
-  **Construction depth** 71/74 mm

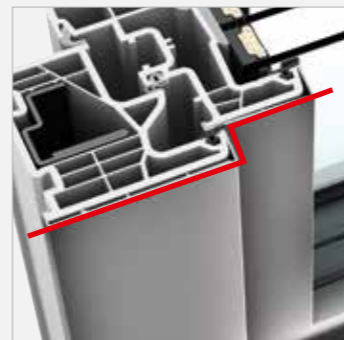
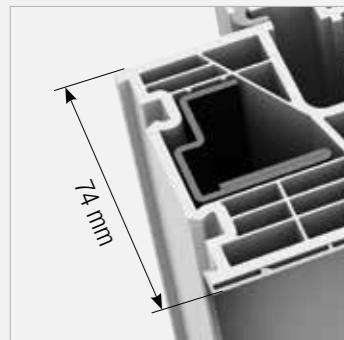

## KF 310

This sleek window features our proven Internorm technology and provides the best thermal insulation and noise reduction performance. The KF 310 is also available as a balcony or patio door with an integrated Juliet balcony. Choose from a wide selection of aluminium colours, glazing and handle options.





# KF 320

UPVC & UPVC-ALUMINIUM WINDOW



**I-tec Glazing**

studio

-  **Thermal insulation**  $U_w$  as low as 0.65 W/(m<sup>2</sup>K)
-  **Noise reduction** up to 45 dB
-  **Security** up to RC1N, RC2
-  **Locking** concealed
-  **Construction depth** 71/74 mm

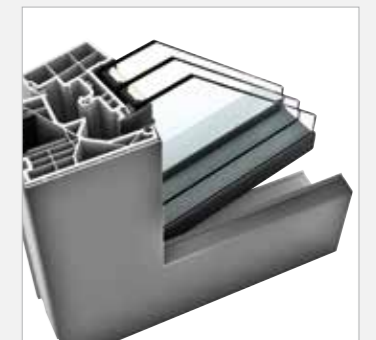
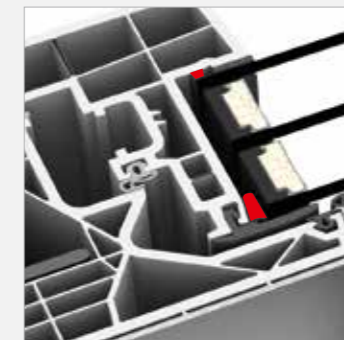

## KF 320



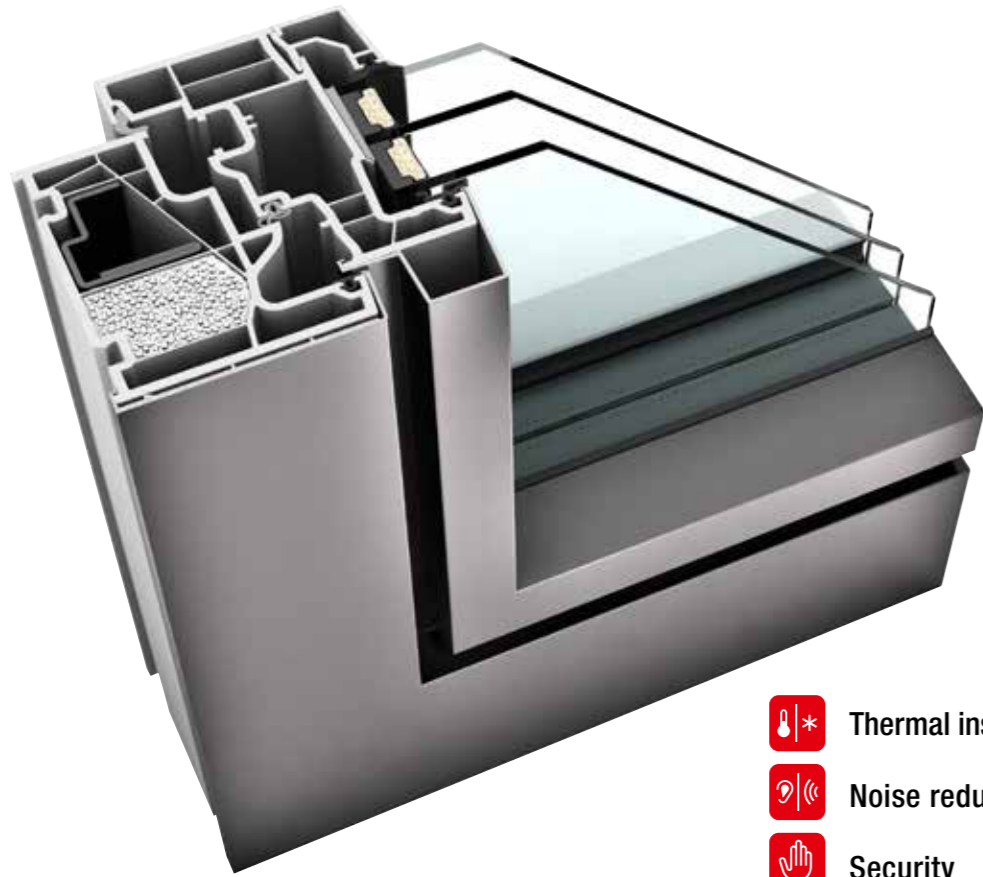

The innovative glass sash of the KF 320 gives the impression of fixed glazing from the outside, despite being a fully functioning opening window. It is available in classic white uPVC or with aluminium cladding on the exterior. I-tec glazing provides excellent stability, security and thermal insulation.

# KF 410

UPVC & UPVC-ALUMINIUM WINDOW



- I-tec Glazing**
  - I-tec Ventilation**
  - I-tec Insulation**
  - I-tec Connect**
- studio

-  **Thermal insulation**  $U_w$  as low as 0.62 W/(m<sup>2</sup>K)
-  **Noise reduction** up to 47 dB
-  **Security** up to RC1N, RC2
-  **Locking** concealed
-  **Construction depth** 90/93 mm

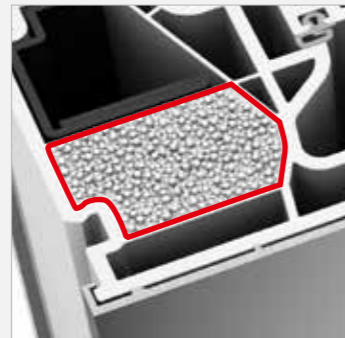

## KF 410



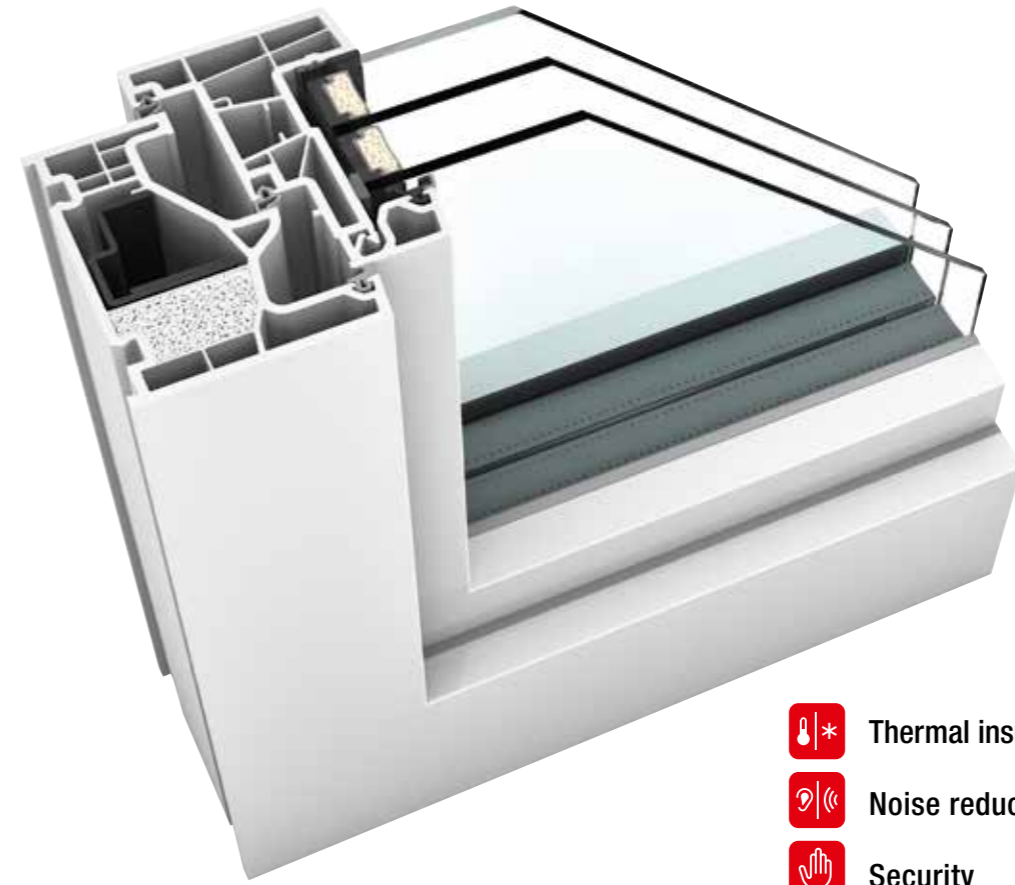

The popular KF 410 is available in all four design styles and is therefore suitable for all types of architecture. I-tec Insulation, which includes insulating granulate that evenly fills the hollow chambers, provides considerable improvement in thermal performance. Also available with I-tec Ventilation to achieve ideal room temperature and living conditions.

# **NEW** KF 510

UPVC & UPVC-ALUMINIUM WINDOW



- I-tec Insulation**
  - I-tec Glazing**
  - I-tec Secure**
- home pure

-  **Thermal insulation**  $U_w$  as low as 0.63 W/(m<sup>2</sup>K)
-  **Noise reduction** up to 46 dB
-  **Security** RC2, RC3
-  **Locking** fully integrated
-  **Construction depth** 90/93 mm

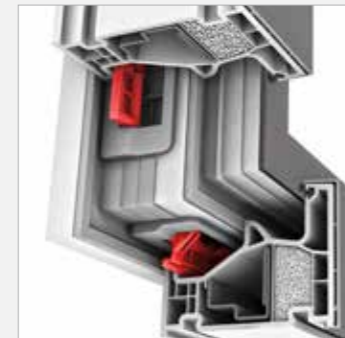

## KF 510

The particularly slim and modern frame of the KF 510 results in an even larger area of glazing to allow maximum light transmission and improved living. The fully integrated I-tec Secure system provides enhanced security thanks to the patented flap mechanism, which presses into all four sides of the frame when locking, making it virtually impossible to lever the window. The concealed hardware also makes it easy to clean, and combined with I-tec Insulation and I-tec Glazing, the new KF 510 offers the ideal window solution.



# KF 520



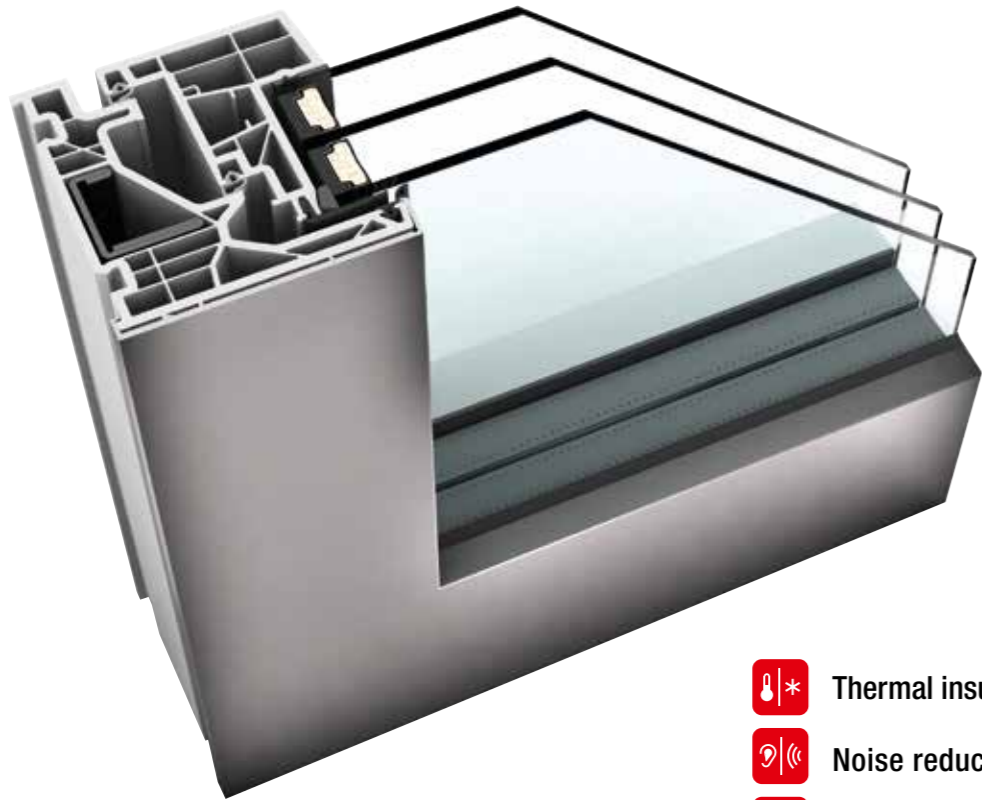

UPVC & UPVC-ALUMINIUM WINDOW



**I-tec Glazing**

**I-tec Secure**

studio

-  **Thermal insulation**  $U_w$  as low as 0.63 W/(m<sup>2</sup>K)
-  **Noise reduction** up to 46 dB
-  **Security** up to RC2, RC3
-  **Locking** fully integrated
-  **Construction depth** 90/93 mm

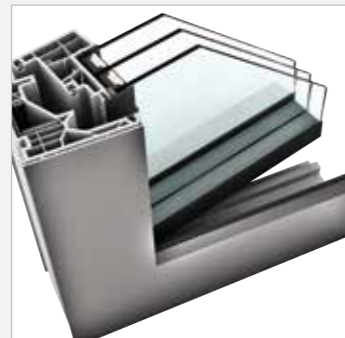

## KF 520

Ideal for modern architecture, this innovative window system looks like fixed glazing from the outside but functions like a normal window. The revolutionary I-tec Secure can achieve the highest RC3 security rating, making it one of the safest windows on the market.



*A modern window for a cosy space:  
the KF 520 invites you to sit next to it.*





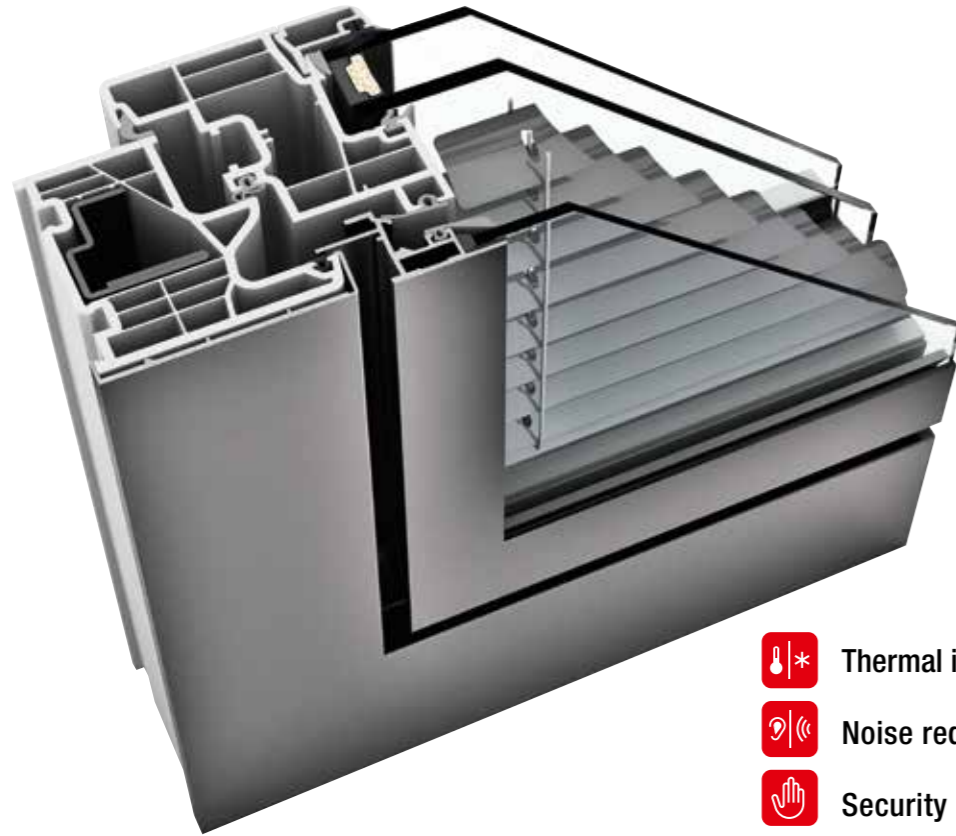

# KV 350

UPVC-ALUMINIUM WINDOW WITH INTEGRATED BLIND



I-tec Glazing  
I-tec Shading  
I-tec Connect

home pure

-  **Thermal insulation**  $U_w$  as low as 0.79 W/(m<sup>2</sup>K)
-  **Noise reduction** up to 44 dB
-  **Security** up to RC1N, RC2
-  **Locking** concealed
-  **Construction depth** 74 mm

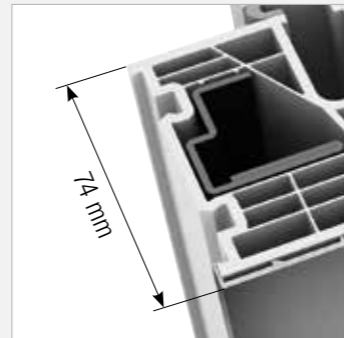
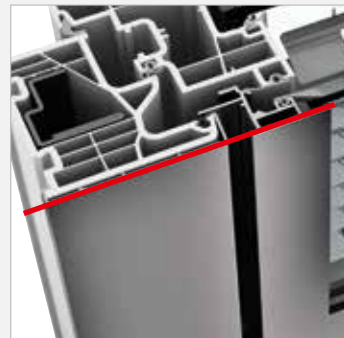

## KV 350

This stylish and slim window, with a construction depth of only 74mm, benefits from integrated, accessible blinds between glass panes. Providing sun protection and privacy, and available with different blind options, the KV 350 can be perfectly matched with the KF 310 uPVC-Aluminum window. The 6-chamber frame profile, combined with the I-tec Glazing, offers improved thermal performance, noise reduction, as well as protection from damp entering the cavities.



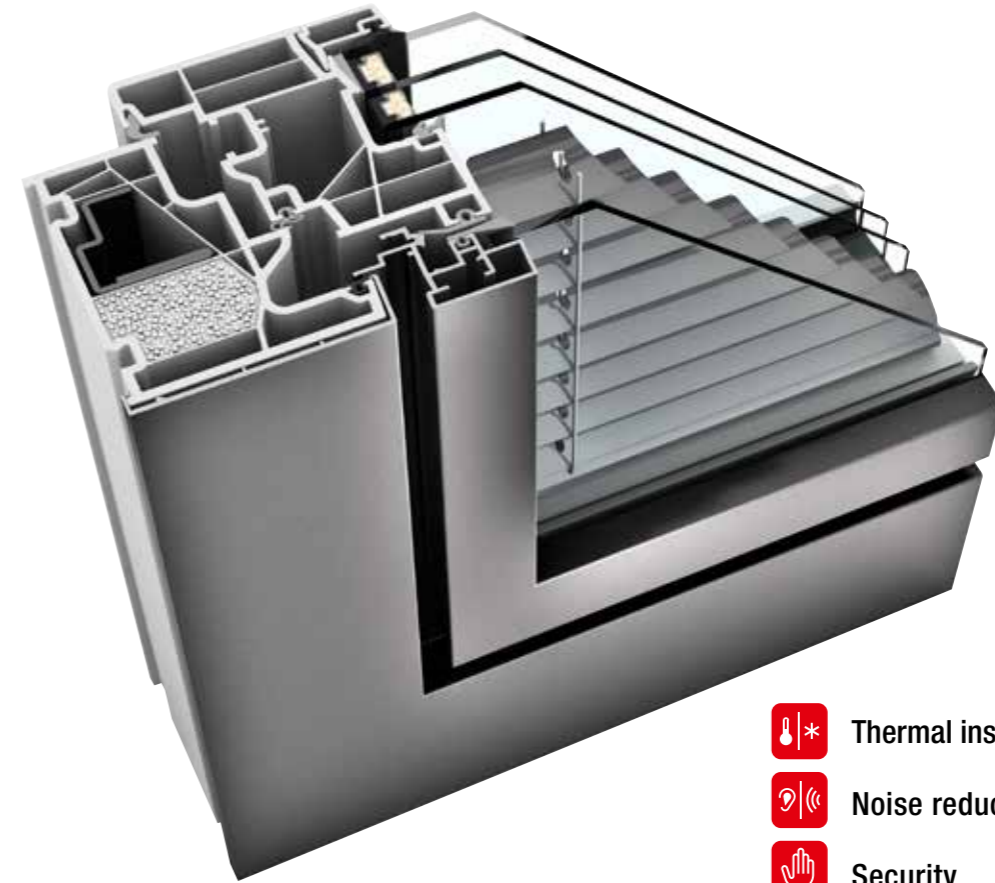

# KV 440

UPVC-ALUMINIUM WINDOW WITH INTEGRATED BLIND



I-tec Glazing  
I-tec Shading  
I-tec Ventilation  
I-tec Insulation  
I-tec Connect

home pure

-  **Thermal insulation**  $U_w$  as low as 0.64 W/(m<sup>2</sup>K)
-  **Noise reduction** up to 45 dB
-  **Security** up to RC1N, RC2
-  **Locking** concealed
-  **Construction depth** 93 mm



## KV 440

With the KV 440, the blind is fully integrated between accessible glass panes and is therefore protected from wind, rain and dirt, whilst still offering outstanding thermal performance with I-tec Insulation. Available with Venetian, Roman and Duette blinds in a selection of colours, the KV 440 offers privacy and sun protection, even for renovations or facades where roller shutters are not possible. The I-tec Shading option offers operation of the blinds via a photovoltaic module using solar energy, therefore not requiring an external power source.

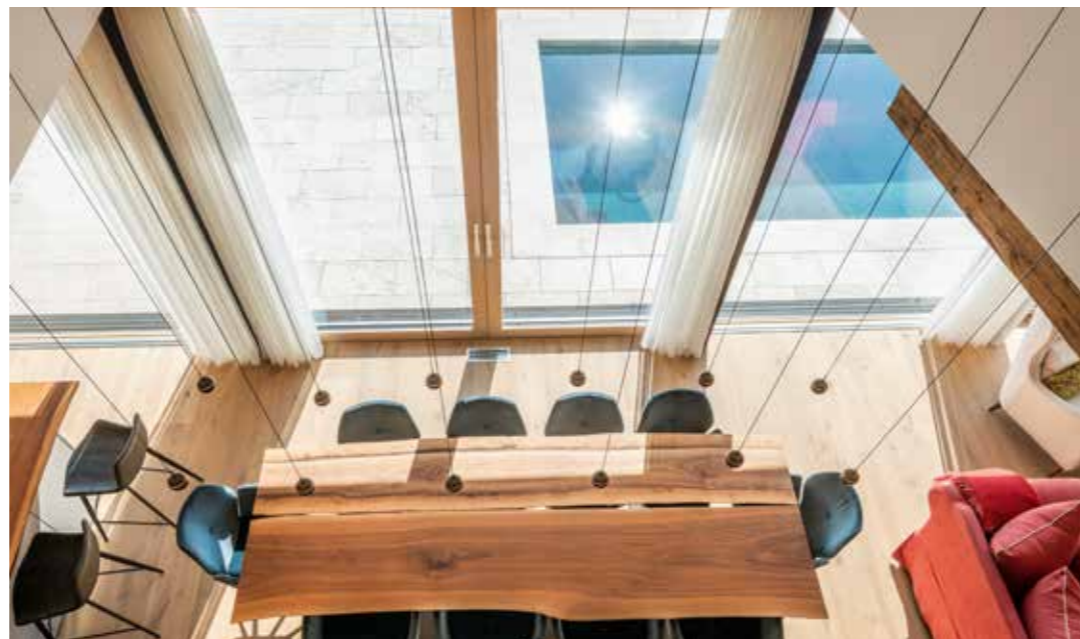

## THE WINNER INTERNORM PHOTO CONTEST 2021

This exclusive property perfectly combines timber and glass, both externally and internally, to create a natural environment. The large areas of glazing allow light to flood the home, making it feel bright and comfortable.

New-build (AT) with composite Timber-Aluminium HF 410 windows and HS 330 Lift & Slide doors.





# HF 310

TIMBER-ALUMINIUM WINDOW



I-tec Glazing

home pure

-  **Thermal insulation**  $U_w$  as low as 0.62 W/(m<sup>2</sup>K)
-  **Noise reduction** up to 46 dB
-  **Security** up to RC1N, RC2
-  **Locking** concealed
-  **Construction depth** 85 mm

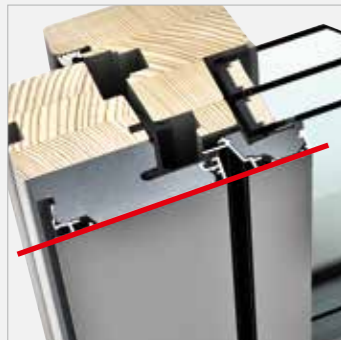

## HF 310

The HF 310 enhances any living space with its natural timber finish. The insulating foam between the internal timber and external aluminium cladding provides outstanding thermal performance. I-tec Glazing means that the glass unit is bonded into the sash, therefore providing a continuous connection between the glazing and frame. The benefits are improved stability and burglary protection. Continuous triple gaskets prevent water from penetrating the timber.

# HF 410



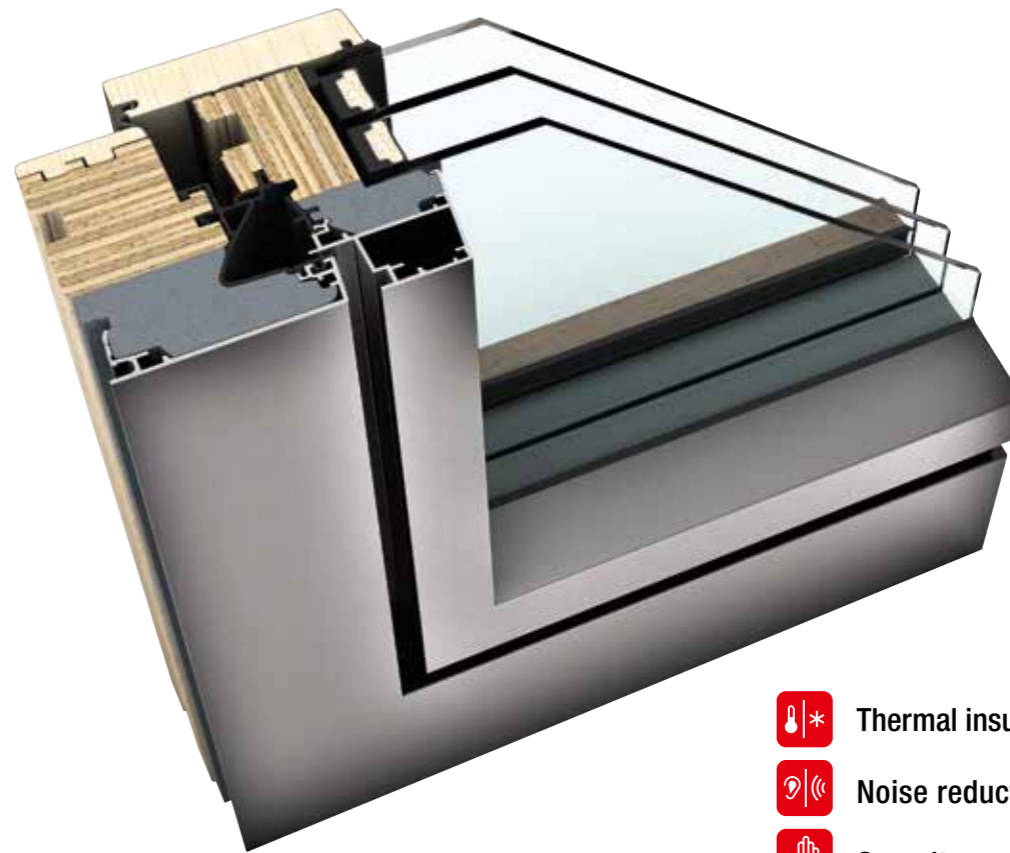

TIMBER-ALUMINIUM WINDOW



I-tec Core

I-tec Glazing

studio

-  **Thermal insulation**  $U_w$  as low as 0.65 W/(m<sup>2</sup>K)
-  **Noise reduction** up to 45 dB
-  **Security** up to RC1N, RC2
-  **Locking** concealed
-  **Construction depth** 85 mm



## HF 410

The unique I-tec Core technology of thin, laminated timber layers, makes the HF 410 exceptionally stable and robust, allowing the manufacture of even larger window sizes. The combination of timber, insulating foam and aluminium cladding provides superior thermal performance. Sustainably sourced timber options and a wide choice of colours offers unlimited interior design possibilities.

**NEW HF 510**



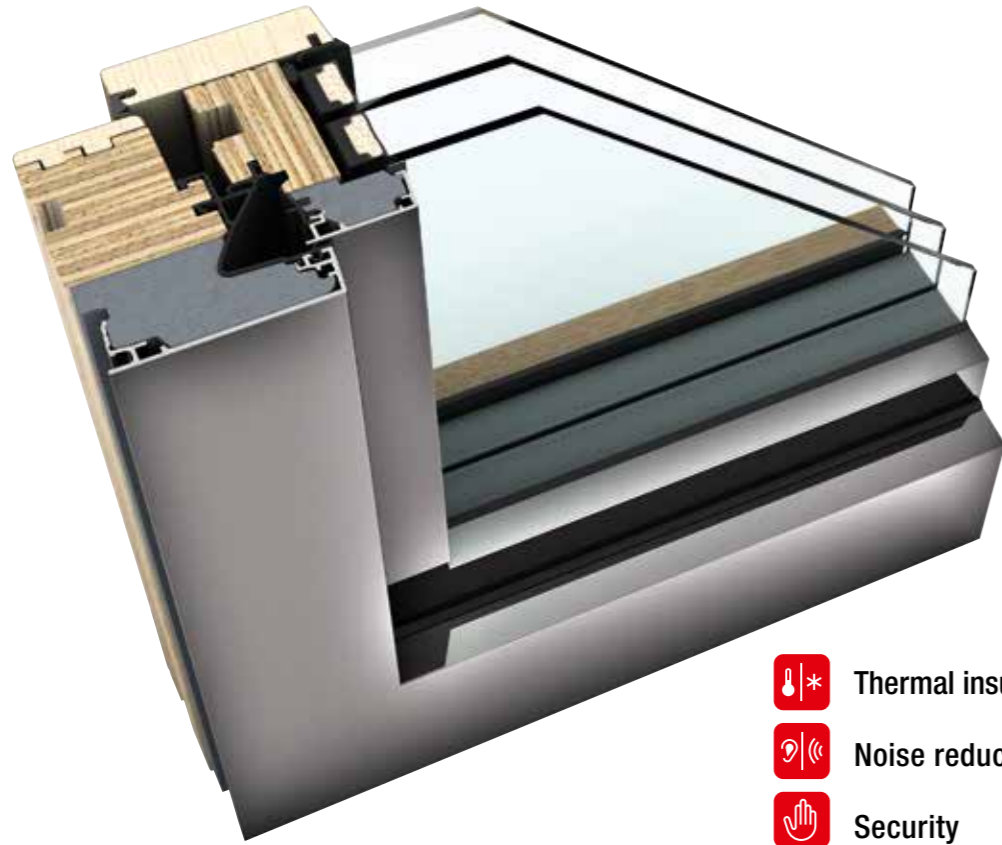

TIMBER-ALUMINIUM WINDOW



I-tec Core

I-tec Glazing

home pure

-  **Thermal insulation**  $U_w$  as low as 0.65 W/(m<sup>2</sup>K)
-  **Noise reduction** up to 44 dB
-  **Security** RC1N, RC2
-  **Locking** concealed
-  **Construction depth** 85 mm



**HF 510**

Clean lines, a slim frame and even larger areas of glazing make the new HF 510 the perfect window for anyone wanting to create a brighter, more comfortable and stylish home. The square, linear features of sash and frame make design style home pure the ideal window for modern architecture. The exceptional I-tec Core provides strength, stability and security to the frame, therefore making larger window solutions possible. A wide choice of sustainable internal timber options, as well as external aluminium colours, make this new addition to the Timber-Aluminium range the window of choice.

**HV 450**

TIMBER-ALUMINIUM WINDOW WITH INTEGRATED BLIND

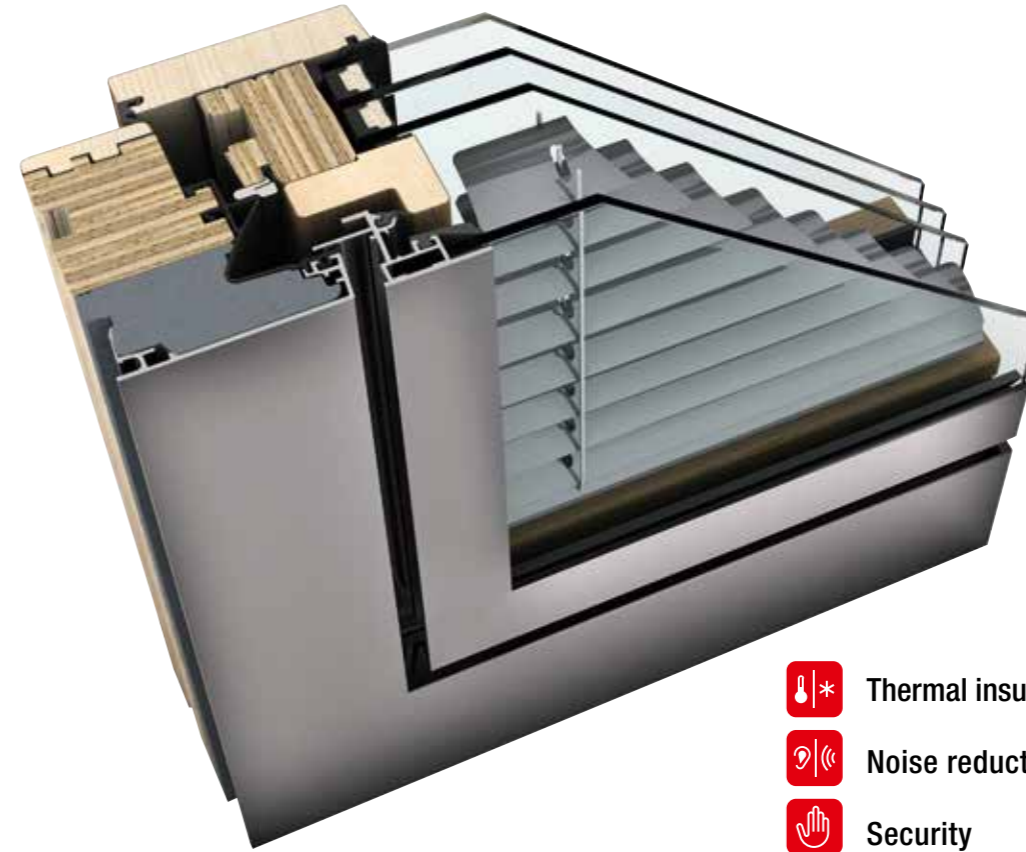





I-tec Glazing

I-tec Shading

I-tec Core

I-tec Connect

home pure

-  **Thermal insulation**  $U_w$  as low as 0.62 W/(m<sup>2</sup>K)
-  **Noise reduction** up to 46 dB
-  **Security** up to RC1N, RC2
-  **Locking** concealed
-  **Construction depth** 85 mm



**HV 450**

The thermally efficient HV 450, with blinds integrated between accessible glass panes, offers quadruple protection: sun, privacy, thermal and noise. With a choice of styles and colours, the integrated blinds are protected from wind, rain and dirt. Also available as manual or hard-wired option, the I-tec Shading solution offers operation of the blinds via a photo-voltaic module using solar energy, therefore not requiring an external power source. All Internorm shading options can be integrated into a Smart Home system.

# ENTRANCE DOORS

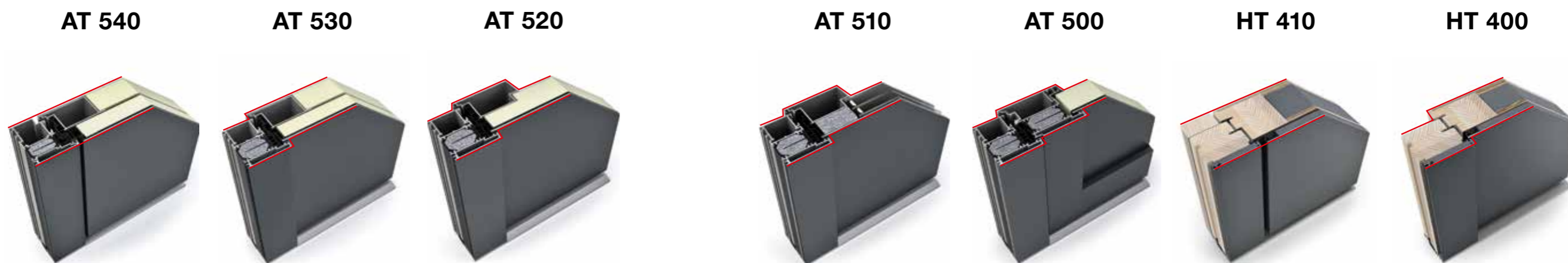
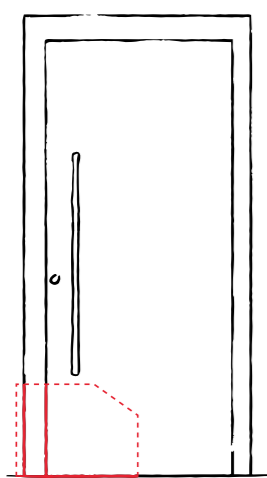

Material	Aluminium	Aluminium	Aluminium	Aluminium	Aluminium	Timber-Aluminium	Timber-Aluminium
Design	Flush inside and outside	Square edge on inside and outside	Round edge on inside, square edge on outside	Round edge on inside, square edge on outside	Round edge on inside and outside	Flush inside and outside	Square edge on inside and outside
Thermal insulation <small>in W/(m²K)</small>	U <sub>D</sub> up to 0.78	U <sub>D</sub> up to 0.75	U <sub>D</sub> up to 0.81	U <sub>D</sub> up to 0.98	U <sub>D</sub> up to 0.91	U <sub>D</sub> up to 0.58	U <sub>D</sub> up to 0.73
Noise reduction <small>in dB</small>	up to 35	up to 34	up to 32	up to 38	up to 40	up to 34	up to 34
Security	up to RC2	up to RC2	up to RC2	up to RC2	up to RC3	up to RC2	up to RC2
Locking	Multi-point locking	Multi-point locking	Multi-point locking	Multi-point locking	Multi-point locking	Multi-point locking	Multi-point locking
Construction Depth <small>in mm</small>	93	93	93	93	93	121	85
Gasket	3	3	3	3	3	3	3
Threshold	Thermally broken	Thermally broken	Thermally broken	Thermally broken	Thermally broken	Thermally broken	Thermally broken
Insulation	3-chamber frame profile, insulating foam core	3-chamber frame profile, insulating foam core	3-chamber frame profile, insulating foam core	3-chamber frame profile, insulating foam core	3-chamber frame profile, insulating foam core	Thermal foam insulation	Thermal foam insulation

# SERIES.F

## FLUSH & LINEAR

Solid flush doors keep your home private. Create your own minimalist entrance door with discreet groove milling and trims. A choice of straight or recessed handles will add to the overall design to create an impressive and modern entrance area.



### FG

Colour: HFM14  
Handle: EGS01  
Order no.: F0003

AT 540 AT 530 AT 520 AT 500 **HT 410** HT 400



### FO

Colour: HFM05  
Handle: RGS01  
Designer base: Alunox 20 mm  
Order no.: F0005

**AT 540** AT 530 AT 520 AT 500 HT 410 HT 400



### FP

Colour: Frame HM704, sash HM704, M916  
Handle: KGS03  
Order no.: F0006

**AT 540** AT 530 AT 520 AT 500 HT 410 HT 400



### FA

Colour: Frame RAL 9005, sash SD07 Art-Stone  
Handle: KGS04  
Order no.: F0001

AT 540 **AT 530** AT 520 AT 510 AT 500 HT 410 HT 400

# SERIES.V

## MODERN & VISIONARY

Stunning new designs and exceptional quality meet even the most demanding ideals of modern living. Our new designer doors combine elegance and individuality and surprise with stylish detailing.



### VD

Colour: RAL9005  
Handle: GSHG black  
Order no.: V0001

AT 540 AT 530



### VG

Colour: Frame RAL 9005, sash SD10 old timber look  
Handle: GKVV black  
Order no.: V0003

AT 540 AT 530



### VK

Colour: Frame HM819, sash HM819, RAL9005  
Handle: GPRV black  
Order no.: V0005

AT 540 AT 530



### VP

Colour: Frame RAL 9005, sash SD03 Art-Concrete, RAL9005  
Handle: GSIV black  
Order no.: V0004

AT 540 AT 530



# SERIES.P

## BALANCED & STRUCTURED

This extensive range of doors impresses with its simplicity and symmetry. Whether you opt for a full length slim glass window or prefer perfectly aligned smaller windows in the centre or the side, the choice is yours.

To create an even more individual entrance door, you have the option to add milled grooves or decorative trims.



### PG

Colour: Frame HM721, sash SD06 Art-Steel  
Handle: RGS02  
Glass: Satinato white  
Order no.: P0004

AT 540 AT 530 AT 520 AT 510 AT 500 HT 410 HT 400



### PS

Colour: HM817  
Handle: GSI03 black  
Motif glass: MP43FE  
Order no.: P0012

AT 540 AT 530 AT 520 AT 500 HT 410 HT 400



### PK

Colour: M916  
Handle: RGS03  
Glass: Satinato white  
Order no.: P0006

AT 540 AT 530 AT 520 AT 500 HT 410 HT 400



### PP

Colour: HFM12  
Handle: RGS05  
Glass: Satinato white  
Order no.: P0009

AT 540 AT 530 AT 520 AT 510 AT 500 HT 410 HT 400

# SERIES.D

## DISCREET & ELEGANT

This beautifully designed range focuses on discreet, narrow glass windows and rectangular cut-outs, enhancing the overall appearance. Milled grooves and decorative trims add further individual touches.



### DD

Colour: HM716  
Handle: GOK60  
Glass: Satinato white  
Designer panels: decorative trim  
Designer base: Alunox 20 mm  
Order no.: D0003

AT 540 AT 530 AT 520 AT 500 **HT 410** HT 400



### DM

Colour: Frame HFM12, sash HFM12, M916  
Handle: HGS04  
Glass: Satinato white  
Order no.: D0006

AT 540 AT 530 AT 520 **AT 500** HT 410 HT 400



### DH

Colour: Frame RAL9017, sash SD03 Art-Concrete  
Handle: KGS04 black  
Designer panels: decorative trim  
Glass: Satinato white  
Order no.: D0005

AT 540 **AT 530** AT 520 AT 500 HT 410 HT 400



### DP

Colour: RAL5010  
Handle: GD25  
Glass: Satinato white  
Order no.: D0007

AT 520 **AT 500** HT 400

# SERIES.G

## CONCISE & CLEAR

With the third series in this range, the emphasis is very clearly on the glass elements. Depending on model and personal preference, milled grooves and decorative trims can be added.



### GA

Colour: HM716  
Handle: HS42  
Glass: Satinato white  
Order no.: G0001

AT 540 AT 530 AT 520 AT 510 AT 500 HT 410 HT 400



### GD

Colour: HFM05  
Handle: KGS04  
Glass: Satinato white  
Designer base: Alunox 80 mm  
Order no.: G0002

AT 540 AT 530 AT 520 AT 510 AT 500 HT 410 HT 400



### GJ

Colour: Frame HF735, sash HF735, HF716  
Handle: SG13  
Glass: Satinato white  
Designer base: Alunox 80 mm  
Order no.: G0004

AT 540 AT 530 AT 520 AT 500 HT 410 HT 400



### GG

Colour: HF113  
Handle: RGS05  
Glass: Satinato white, alunox glass surround  
Order no.: G0003

AT 540 AT 530 AT 520 AT 500 HT 410 HT 400

# SERIES.A

## TRADITIONAL & CLASSIC

If you are looking for a design to match a more traditional architectural style, then doors in this series will meet your needs. The focus is on decorative elements, detailed straight or curved panelling, combined with glazed sections.



### AM

Colour: M916  
Handle: HS10  
Glass: D03E  
Order no.: A0007

AT 520 AT 500



### AJ

Colour: HFM04  
Handle: GD20  
Glass: D41E  
Order no.: A0006

AT 520 AT 500



### AA

Colour: HDS08  
Handle: HS10  
Glass: Satinato white  
Order no.: A0001

AT 530 AT 520 AT 500 HT 400



### AG

Colour: Frame HF113, sash HF113, M916  
Handle: HS40  
Glass: Satinato white  
Order no.: A0003

AT 530 AT 520 AT 500 HT 400

# SERIES.S

## STYLISH & TIMELESS

This series focuses on striking and unconventional designs by integrating a selection of unique and special glass features, creating timeless and individual entrance doors.



### SG

Colour: M916  
Handle: HS30  
Glass: Satinato white, alunox glass surround  
Designer base: Alunox 80 mm  
Order no.: S0003

AT 520 AT 500



### SA

Colour: HFM05  
Handle: HS30  
Glass: Satinato white  
Designer base: Alunox 80 mm  
Order no.: S0001

AT 520 AT 500



### SJ

Colour: HFM22  
Handle: RSS03  
Glass: Satinato white  
Order no.: S0004

AT 520 AT 510 AT 500



### SD

Colour: HDS07  
Handle: GPR60  
Glass: Satinato white  
Designer base: Alunox 20 mm  
Order no.: S0002

AT 520 AT 500



**MODERN MONOCHROME ARCHITECTURE**

Open plan living is clearly defined by black and white architectural feature areas.

Detached house (RO), door: AT 540, windows: KF 405

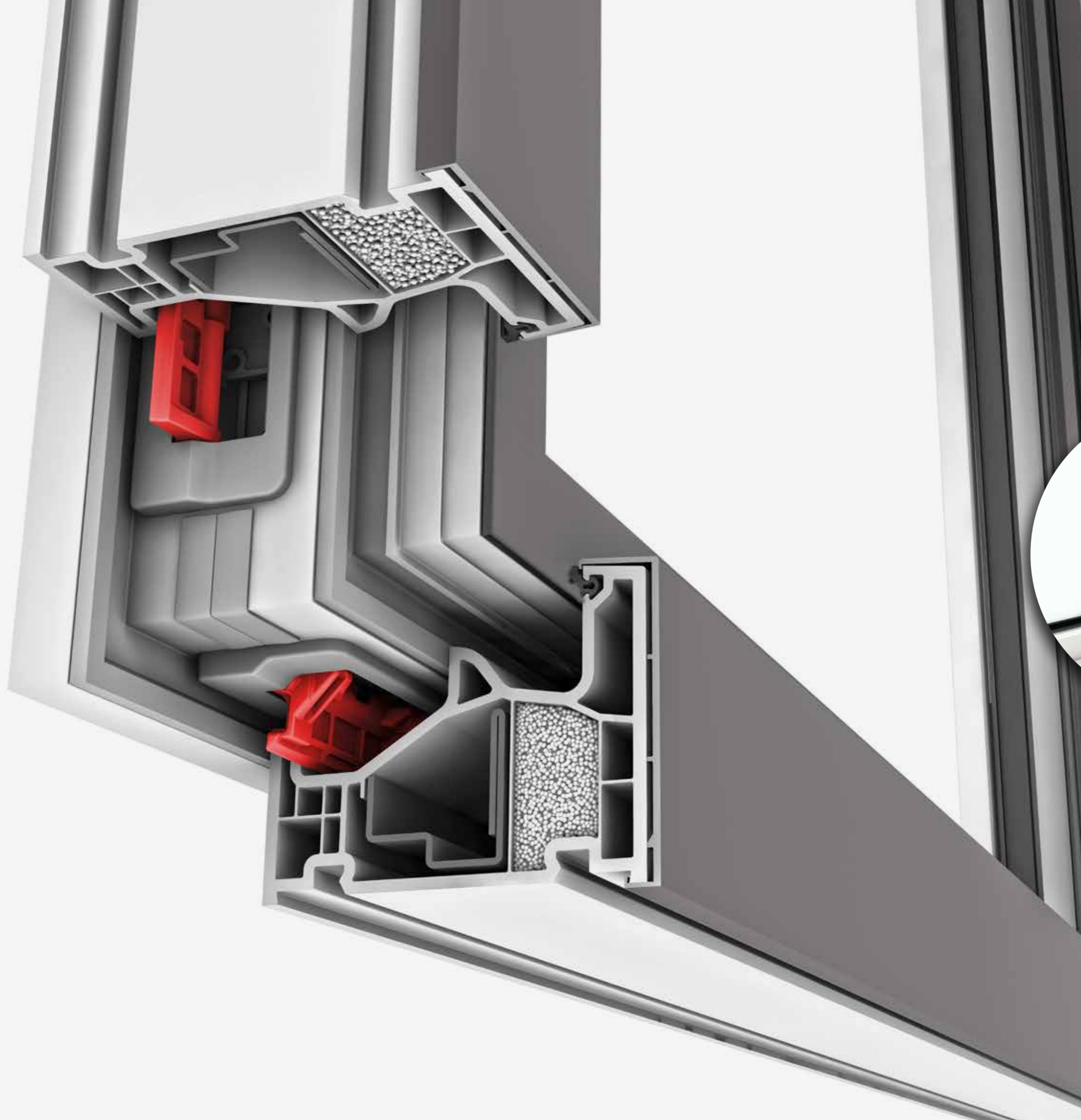

# I-TEC INNOVATIONS

NEW STANDARDS  
FROM INTERNORM.



Under the heading **I-tec**, Internorm has been developing a series of revolutionary, innovative technologies to meet the increasing demands on design, technology, quality and comfort.

- **I-tec Secure**
- **I-tec Core**
- **I-tec Ventilation**
- **I-tec Shading**
- **I-tec Glazing**
- **I-tec Insulation**
- **I-tec Connect**

Discover Internorm's innovative technologies and find out why I-tec is so unique.



## ADVANTAGES

- Enhanced security up to RC3 available, achievable with integrated flaps
- Levering of window is practically impossible
- Clean look as locking hardware is concealed
- Easy to clean window frame
- Modern glass architecture with slim sightlines

**I-tec Secure**

## FEEL SAFE

UNRIVALLED, FULLY INTEGRATED LOCKING UP TO RC3

It is not only the people who surround us but also the furnishings in our home as well as the view to the outside that contribute to feeling comfortable in our own four walls. Feeling safe and secure also plays an important part.

The unrivalled I-tec Secure locking system ensures that your windows provide reliable protection. The customary locking pegs are replaced by flaps that securely lock the window sash to the frame, making levering of the window practically impossible.

**I-tec Secure is integrated into the new KF 510 and KF 520** as standard and is available up to security class RC3 on request.

Cleaning the windows is made easier with these flaps as most of the hardware and locking parts are concealed, leaving a smooth and easy to clean uPVC surface.

I-tec Secure is integrated into the new KF 410 and KF 520 uPVC and uPVC-Aluminium systems. It can reach security class RC2N with an optional lockable handle and is available up to security class RC3 on request.



Discover more about I-tec Secure  
[www.internorm.com/en-uk/products/i-tec-innovations](http://www.internorm.com/en-uk/products/i-tec-innovations)



## ADVANTAGES

- Highly stable core in window frame and sash
- Slim sightlines for more light
- Match timber types and colours to your interior – large choice of colours and timbers
- Attractive price-performance ratio
- Option to match windows and lift & slide doors.

**I-tec Core**

## STRENGTH AND STABILITY

WIDE SELECTION OF TIMBER OPTIONS

Today's open and bright living spaces with large areas of glazing require exceptional window solutions. High stability, strength, as well as slim sightlines and option to match the interior are all important factors.

With the I-tec Core, Internorm windows are able to achieve just that. Usually only used for roofing beams and rafters, the thin laminated layers of timber are exceptionally resistant, durable and strong. These properties enable the manufacture of large window solutions and lift & slide doors. The slim frame further enhances the aesthetic of these windows. This

high-tech material is also supporting the environment by conserving resource. It is sustainable, and due to its strength, suitable for large dimensions. The wide choice of timber, such as spruce, larch, oak, ash and walnut, used on the inside of our windows and lift & slide doors, can be matched to your individual interior decoration, furniture, flooring and doors.



Discover more about I-tec Core  
[www.internorm.com/en-uk/products/i-tec-innovations](http://www.internorm.com/en-uk/products/i-tec-innovations)





## ADVANTAGES

- Each I-tec ventilation and thus each window and room can be controlled individually – for healthy living
- Reduced heat loss and increased safety – the window remains closed during ventilation
- Integrated filters ensure that dust and pollen are collected
- Control available via Smart Home solutions
- Fresh air without noise from outside
- Heat recovery up to 93%

### I-tec Ventilation

## ALWAYS FRESH AIR

### AUTOMATIC AND INDIVIDUAL

The time we spend in rooms and how we use them differs. We usually spend only a short period of time in the bathroom but generate a lot of steam, and therefore humidity, when showering. On the other hand, we spend all night in our bedroom emitting considerable amounts of CO<sub>2</sub> during our sleep. Store rooms or guest bedrooms are only used occasionally and have to be aired primarily to prevent mould.

The amount of fresh air we require therefore depends on the room. Internorm has developed I-tec Ventilation which meets these individual requirements. The ventilation system

is integrated into the window frame, allowing each room to be controlled individually. More ventilation in one room, only a light breeze in another, all depending on how much fresh air is needed. In automatic mode I-tec Ventilation measures the humidity of the used air and turns on automatically, if required. I-tec Ventilation guarantees fresh air and an optimum environment in your home.

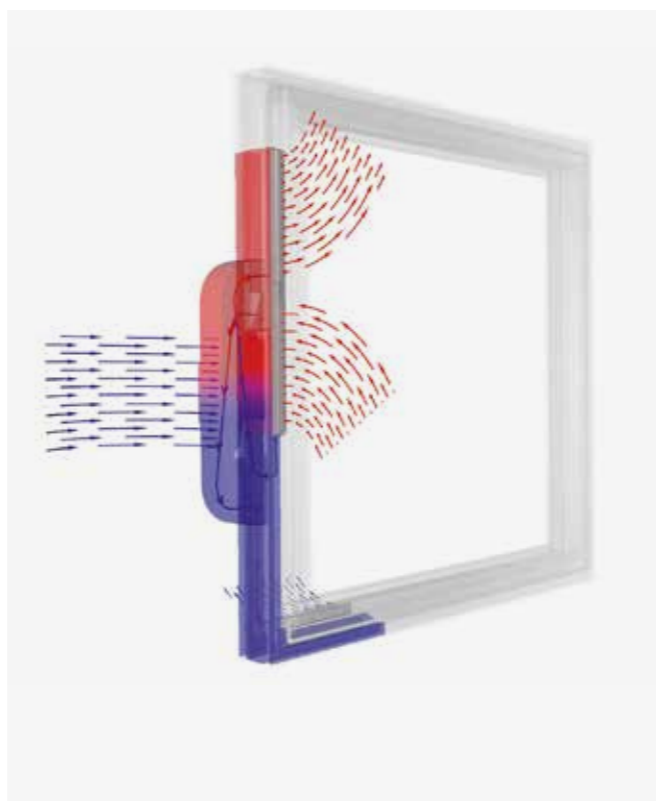

Discover more about the I-tec Ventilation.  
[www.internorm.com/en-uk/products/i-tec-innovations](http://www.internorm.com/en-uk/products/i-tec-innovations)

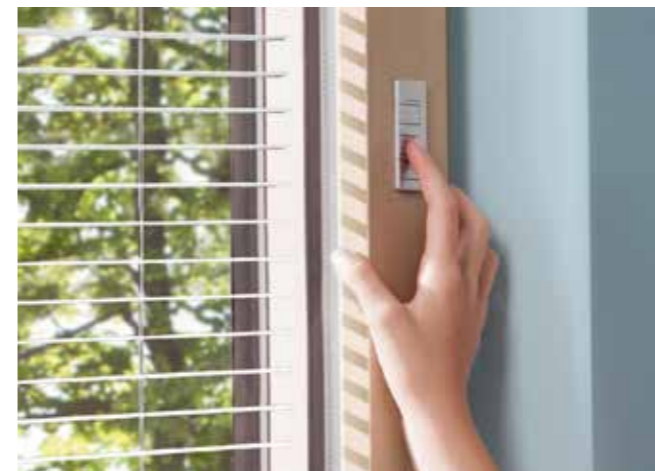

## ADVANTAGES

- No electricity needed due to the photovoltaic module
- Use of energy gain in winter – reduction of heating costs
- Automatic functions such as day/night recognition and measuring of solar irradiation
- Manual control available directly at the window frame
- Convenient control also available via Smart Home solutions
- Photovoltaic module and sun protection integrated between glass panes

### I-tec Shading

## SOLAR POWER INSTEAD OF ELECTRICITY

### SELF-SUFFICIENT SUN PROTECTION

With renovations in particular, you want as little dust and dirt as possible, avoiding unnecessary work to add additional cabling.

The clever I-tec Shading is the perfect solution for adding sun protection and privacy. The energy required to operate the integrated blind is generated by a photovoltaic module or solar panel. No hard wiring is necessary as the unit is totally self contained within the window. Available as Venetian, Roman or Duette option, the blind can be operated

via a remote control or integrated into a Smart Home system. Day/night or solar radiation recognition can all be programmed to automatically open, close or adjust the blinds to provide privacy or stop the home from overheating. KV and HV window systems can be fitted with I-tec Shading.



Discover more about the I-tec Shading.  
[www.internorm.com/en-uk/products/i-tec-innovations](http://www.internorm.com/en-uk/products/i-tec-innovations)



## ADVANTAGES

### I-TEC GLAZING

- Maximum burglary protection
- Increased stability
- Increased thermal insulation
- Improved noise reduction

### I-TEC INSULATION

- Granulate instead of foam
- Improved thermal insulation
- Hollow chambers filled on all sides

**I-tec** Glazing

**I-tec** Insulation

## CONTINUOUSLY EFFICIENT

### SAFETY ALL AROUND

Quite often, thermally insulating glazing is only sealed at certain points. This means that the glass can easily be pushed or levered out of the frame and optimum thermal insulation cannot be guaranteed.

To ensure maximum security, Internorm windows are fitted with I-tec Glazing as standard. This technology means that glass panes are glued to the sash all the way round. This considerably improves stability, thermal insulation, noise reduction and burglary protection. The system still allows you to easily change the glass.

I-tec Insulation is standard for three Internorm window systems: KF 410, KF 510 and KV 440. A granulate is pushed into the hollow chambers under pressure and therefore completely fills them all the way round. I-tec Insulation provides considerable improvement in thermal insulation.



Discover more about these I-tec innovations. [www.internorm.com/en-uk/products/i-tec-innovations](http://www.internorm.com/en-uk/products/i-tec-innovations)



## ADVANTAGES

- Intelligent control around the window
- Mobile operation of I-tec Ventilation, I-tec Shading, sun protection and fanlights
- Opening monitoring of your windows – also while you are on holidays
- Easy operation
- Individual adjustment possibilities
- Direct integration into central SmartHome solutions of various manufacturers

**I-tec** Connect

## SMART HOME READY

### SMART WINDOWS ARE EASY TO OPERATE

Today's Smart Home solutions can help improve our lives. Whether you are at home or on the road, intelligent automation allows you to control heating, lighting, audio, security, shading, and much more.

I-tec Connect offers a range of intelligent window products that can easily be integrated into different Smart Home systems. Window opening monitoring, I-tec Ventilation, I-tec Shading, blinds or fanlights can be operated via an app on your smartphone or tablet. A simple finger tap will open or close blinds, adjust the light control or regulate the airflow of the ventilation.

All Internorm windows that carry the I-tec Connect label can be fully integrated into Smart Home solutions from Loxone and Mediola. Even the electric Comfort Drive on a lift & slide door can easily be connected to your home network via your Wifi hub.



Discover more about I-tec Connect. [www.internorm.com/en-uk/products/i-tec-innovations](http://www.internorm.com/en-uk/products/i-tec-innovations)





# XL GLAZING

LIFT & SLIDE DOORS  
PANORAMA



Bright, light-filled rooms evoke a sense of freedom for you and your family. Large areas of glazing extend the living area beyond its actual boundaries, creating the feeling of unlimited space and at the same time opening up the view to the outside.

Frameless windows, fixed glazing, glass-to-glass corners, large lift & slide doors, panoramic windows, as well as bespoke solutions offered by Internorm create the ideal solutions for modern architectural glazing. The combination of any of these options allows your dream of opening up your home become reality.

# KS 430

## UPVC & UPVC-ALUMINIUM LIFT & SLIDE DOOR



### NARROW

Narrow sliding frame and frameless elements with 3-sided rendering

### COMFORTABLE

Low threshold without obstruction

### SOFT

Soft handle closure as standard

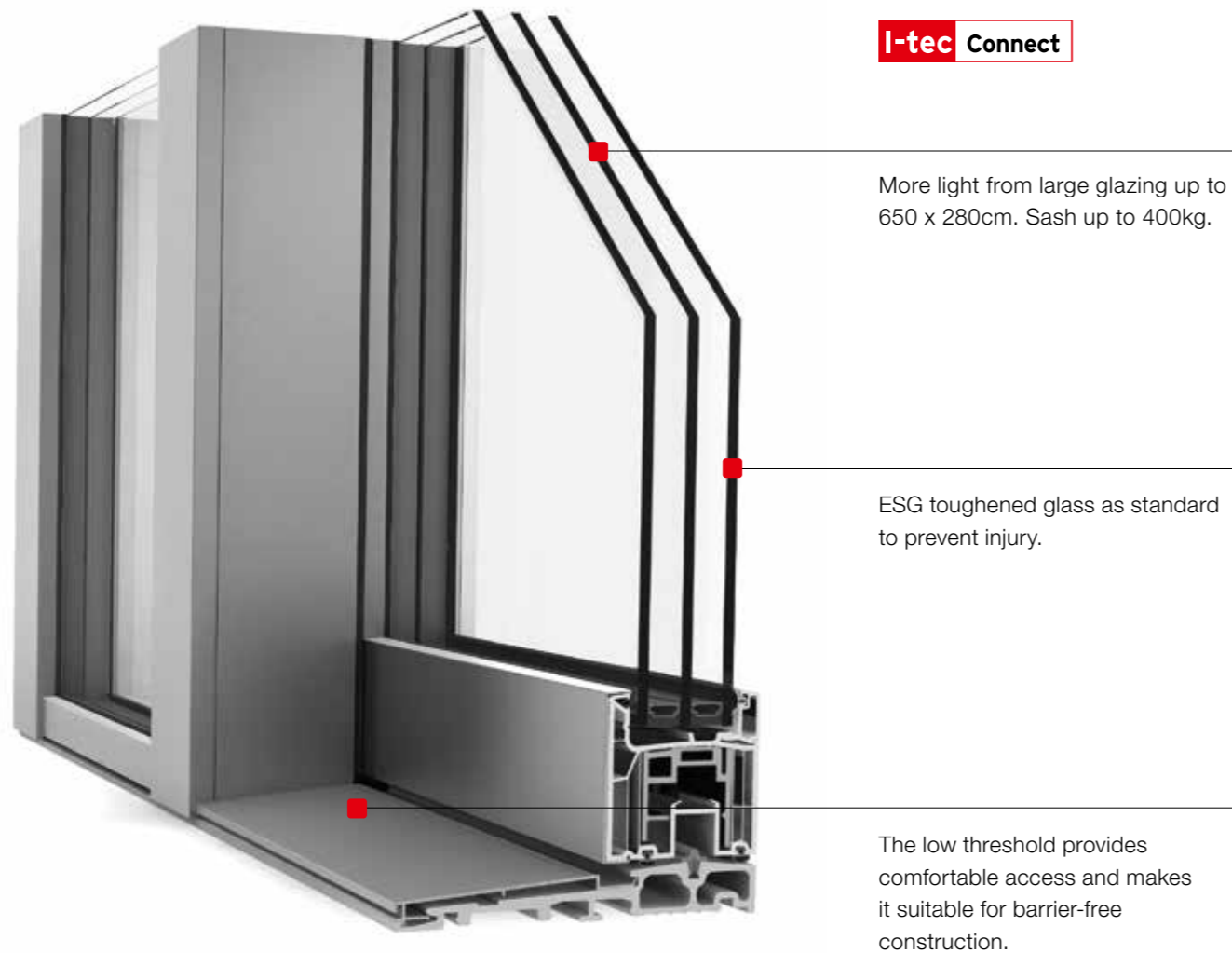

**I-tec Connect**

More light from large glazing up to 650 x 280cm. Sash up to 400kg.

ESG toughened glass as standard to prevent injury.

The low threshold provides comfortable access and makes it suitable for barrier-free construction.



Comfort Drive allows your lift & slide door to be opened via electric operation. Can be integrated into Smart Home system.

**Thermal insulation** up to  $U_w = 0.64 \text{ W}/(\text{m}^2\text{K})$

**Noise reduction** up to 43 dB

**Security** up to RC1N, RC2

# HS 330

## TIMBER-ALUMINIUM LIFT & SLIDE DOOR



### ENERGY-EFFICIENT FRAMELESS

Fibreglass threshold for optimum thermal insulation

### FRAMELESS

Frameless glazing achieved with fully rendered fixed elements

### COMFORTABLE

Easy to lift and slide up to 400kg sash weight

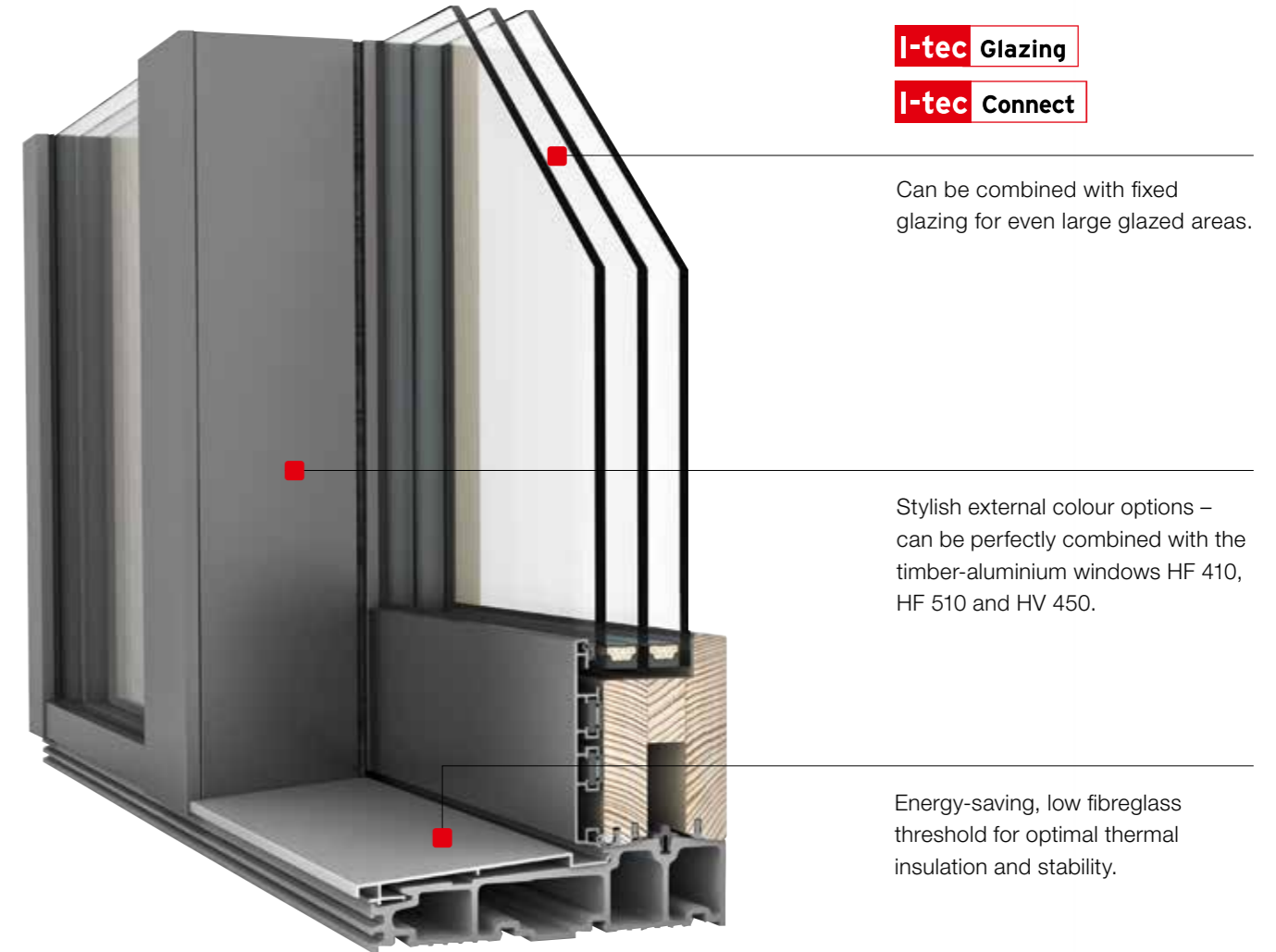

**I-tec Glazing**

**I-tec Connect**

Can be combined with fixed glazing for even large glazed areas.

Stylish external colour options – can be perfectly combined with the timber-aluminium windows HF 410, HF 510 and HV 450.

Energy-saving, low fibreglass threshold for optimal thermal insulation and stability.

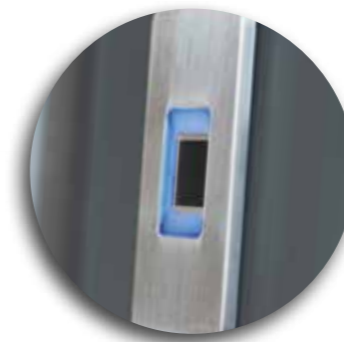

Comfort Drive allows your lift & slide door to be opened via electric operation. Can be integrated into Smart Home system.

**Thermal insulation** up to  $U_w = 0.73 \text{ W}/(\text{m}^2\text{K})$

**Noise reduction** up to 40 dB

**Security** up to RC1N, RC2



# HX 300

## PANORAMA



### OPEN

Glass joint virtually invisible

### BRIGHT

Large glazing up to 10.5m<sup>2</sup>

### FRAMELESS

Frame almost entirely disappears into the facade.



**Thermal insulation** up to  $U_w = 0.74 \text{ W/(m}^2\text{K)}$



**Noise reduction** up to 47 dB



Create visual features with Integrated windows

Triple safety glass for optimal thermal insulation

Strong, glued multi-layered frame construction

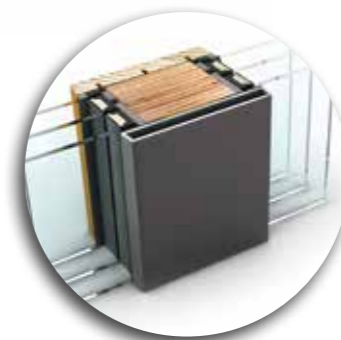
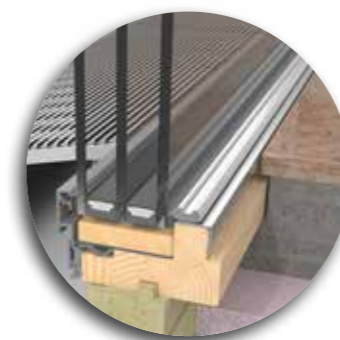



# TIPS

USEFUL ADVICE  
FROM INTERNORM



Safety and energy efficient construction are important considerations when starting a new build or renovation project. This does not have to impact on the overall architecture. Having the option of combining different window materials and incorporating large glazing and lift & slide doors, are important factors in the decision making process.

The vast choice of windows on the market can often be overwhelming and confusing. We therefore recommend to rely on a professional, like an approved Internorm 1<sup>st</sup> window partner, to guide you through the best options for your project. He will provide you with competent advice and qualified installation.

**You will also receive advice on:**

- How to combine materials
- How to achieve maximum security with windows
- Energy efficient renovations
- Professional window installation



# PERFECT COMBINATIONS

TRUE TO STYLE. INDEPENDENT OF MATERIALS. MATCHING.

Individual architecture increases the demand on window design, energy efficiency and comfort. With Internorm, functionality and design are not a contradiction. It is possible to perfectly mix and match uPVC-aluminium and timber-aluminium in one project.

### Same design on the outside – choose between uPVC and timber on the inside

If you prefer a uPVC-aluminium window in the bathroom due to high humidity, but prefer the feel and look of a timber-aluminium window in the living room – no problem. The design style and exterior finish of your windows will look and remain the same. The difference is on the inside where you can choose between classic uPVC or natural timber.

### Consistent architectural style throughout

No matter what design style you choose for your home - avant-garde, contemporary, traditional or timeless – Internorm offers you the perfect solution for combining materials and products to suit your particular need.

### Combine with lift & slide doors

To ensure that you don't miss out on large scale glazing and more light in your home, you can even choose your lift & slide doors in uPVC-aluminium and timber-aluminium to match your windows to achieve a uniform look.

## OUTSIDE – THE SAME



### Aluminium

The aluminium cladding on the outside matches the design style of your house.

## INSIDE – YOUR CHOICE



### uPVC

uPVC is longlasting, maintenance free and perfect for rooms with high humidity, e.g. bathrooms.



### Timber

Timber has a natural, warm feel and is ideal for living spaces and bedrooms.



# FEEL SAFE AND SECURE

RELIABLE. EFFECTIVE. PATENTED.

To feel safe and secure in your own home, burglary protection as well as maximum security for children are fundamental requirements. Quality windows largely contribute to this feeling of safety and with the proven technologies from Internorm, you can protect your family and make it difficult for intruders to enter your home.



### Security locking elements

All Internorm window systems are equipped with standard security hardware. Solid, yet discreet silver designer locking elements, together with octagonal mushroom cams in the frame, provide secure locking (except KF 510 and KF 520).



### I-tec Secure (KF 510 and KF 520)

Internorm's revolutionary locking technology guarantees maximum protection. When locking the window, flaps open and press into the frame on all sides, making it virtually impossible to lever the window.



### Security handle

The new Secustik® window handle contain a jamming-device which provides integrated security. This makes it more difficult to move the window fitting unlawfully from outside. (standard on KF 510 and KF 520 uPVC and uPVC-aluminium windows).



### Lockable handles

Lockable handles offer optimal security for use by children as well as burglary protection. The window is locked with a key and cannot be opened from the inside or outside.

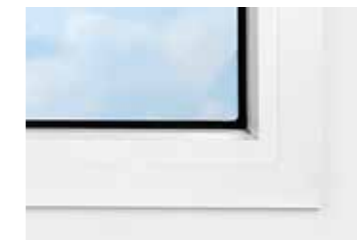

### Concealed hardware

Concealed hardware prevents windows from being levered out of their hinges, with the added benefit of making windows look neat and easy to clean.



### I-tec Glazing

Thanks to Internorm's patented glazing technology, the glass pane cannot be pushed out. The glass is glued into the frame all the way round, making it more secure and stable. Most Internorm window systems include this I-tec innovation as standard.



### Electronic opening detector

Discreet and reliable, these hard wired or wireless locking sensors report whether windows or French doors are open, tilted or locked.









### Laminated glass

Unlike standard glass, laminated glass does not shatter when broken. A tough interlayer bonded between two glass panes ensures that the glass stays in the frame and does not cause injury.





**INTERNORM  
HANDLE COLOURS**

-  F1 Aluminium natural
-  F9 aluminium steel
-  RAL910 white
-  F9714m black matt
-  Brass polished
-  Chrome satin finish
-  Chrome/stainless steel matt
-  Brass matt/aluminium steel

# WINDOW HANDLES

## OUR ENTIRE RANGE AT A GLANCE



The Internorm window handles fit comfortably into your hand and are available as round, square or flat option. We recommend matching the window handles to your existing interior doors and furniture.



**Lift & slide door handle G80 III. in black matt**  
Item no. 36133

**Lift & slide door handle Dallas III. in aluminium natural**  
Item no. 36424

**Lift & slide door handle Softline III. in aluminium natural**  
Item no. 32447

- available in the colours 
- available in the colours 
- available in the colours 

NOTE: Not all handle options are available for each window system. Your Internorm distribution partner will be happy to advise you on the possible combinations.

 <p><b>Handle G80 flat cylinder key hole cover plate III. in aluminium natural</b> Item no. 36435</p> <p>available in the colours </p>	 <p><b>Handle G80 III. in aluminium natural</b> Item no. 36404 (item no. 36505 for KF310/KF320/KV350)</p> <p>available in the colours </p>	 <p><b>Handle G80 lockable III. in aluminium natural</b> Item no. 36400</p> <p>available in the colours </p>	 <p><b>Handle G80 with push button III. in aluminium steel</b> Item no. 36394</p> <p>available in the colours </p>	 <p><b>Secustik® handle G80 III. in aluminium natural</b> Item no. 36428</p> <p>available in the colours </p>
 <p><b>Secustik® handle Austin flat cylinder key hole cover plate III. in black matt</b> Item no. 36170</p> <p>available in the colours </p>	 <p><b>SecuForte® III. in black matt</b> Item no. 36132</p> <p>available in the colours </p>	 <p><b>Secustik® handle Dallas III. in aluminium natural</b> Item no. 36426</p> <p>available in the colours </p>	 <p><b>Standard handle III. in aluminium natural</b> Item no. 33899 (item no. 36504 for KF310/KV350)</p> <p>available in the colours </p>	 <p><b>Handle with push button III. in aluminium natural</b> Item no. 33885</p> <p>available in the colours </p>
 <p><b>Designer handle Bruxelles III. with chrome satin finish</b> Item no. 34592</p> <p>available in the colours </p>	 <p><b>Handle Amsterdam III. in aluminium natural</b> Item no. 36416</p> <p>available in the colours </p>	 <p><b>Designer handle Athanai III. in brass matt/aluminium steel</b> Item no. 34594</p> <p>available in the colours </p>	 <p><b>Handle lockable III. in brass</b> Item no. 33886</p> <p>available in the colours </p>	 <p><b>Designer handle Atlanta III. in brass</b> Item no. 34750</p> <p>available in the colours </p>

# DOOR HANDLES

## RECESSED HANDLES

Both attached and flush possible. Only attached version possible with the AT500 and AT520.



**SG16**  
Recessed handle, 430x100  
Stainless steel  
AT500, AT520, AT530, AT540, HT400, HT410



**SG13**  
Recessed handle, 220x125  
Stainless steel  
AT500, AT520, AT530, AT540, HT400, HT410



**SG17**  
Recessed handle, 110x500  
Stainless steel, black  
AT500, AT520, AT530, AT540, HT400, HT410

LED lighting optional with AT530 and AT540 (ill. p. 98)



**SG18**  
Recessed handle, 110x1400  
Stainless steel  
AT500, AT520, AT530, AT540, HT400, HT410

LED lighting optional with AT530 and AT540 (ill. p. 98)

**GSIV**  
Integrated recessed handle

**GS140**  
406x59

**GS101**  
1000x59

**GS102**  
1200x59

**GS103**  
1400x59

**GSIV**  
Length variable

in the corresponding colour of the door sash, black  
AT500, AT520, AT530, AT540, HT400, HT410

LED lighting optional



## BAR HANDLES

**HGS01**  
Handle bar half-round  
40x1000  
2 supports

**HGS02**  
40x1200  
2 supports

**HGS03**  
40x1400  
2 supports

**HGS04**  
40x1600  
2 supports

Stainless steel, black  
AT500, AT520, AT530, AT540, HT400, HT410

**KGS01A**  
for ekey-dLine  
Square handle bar  
40x1000  
2 supports

**KGS05A**  
for ekey-dLine  
Square handle bar  
40x1800  
3 supports

Stainless steel  
AT530, AT540, HT400, HT410

**KGS01**  
Square handle bar  
40x1000  
2 supports

**KGS02**  
40x1200  
2 supports

**KGS03**  
40x1400  
2 supports

**KGS04**  
40x1600  
3 supports

**KGS05**  
40x1800  
3 supports

**KGS06**  
40x2000  
3 supports

Stainless steel, black  
AT500, AT510, AT520, AT530, AT540, HT400, HT410

**KGS01L**  
(without ill.)  
40x1000  
2 supports with integrated LED lighting

**KGS03L**  
(without ill.)  
40x1400  
2 supports with integrated LED lighting

Stainless steel  
AT530, AT540, HT400, HT410

**EGS01**  
Round handle bar  
Ø 35  
Height variable

Stainless steel  
AT500, AT510, AT520, AT530, AT540, HT400, HT410

**GKV01**  
Square handle bars with straight ends  
30x1000

**GKV02**  
30x1200

**GKV03**  
30x1400

**GKV04**  
30x1600

Stainless steel, black  
AT500, AT520, AT530, AT540, HT400, HT410

**GOK60**  
Handle bar  
Height 600  
2 supports

Stainless steel  
AT500, AT520, AT530, AT540, HT400, HT410

## PUSH AND BRACKET HANDLES



**HS10**  
Push handle  
93x400  
Stainless steel  
AT500, AT510, AT520, AT530, AT540, HT400, HT410



**HS50**  
Push handle  
109x500  
Stainless steel  
AT500, AT510, AT520, AT530, AT540, HT400, HT410



**PD12**  
Aluminium brushed  
AT510, AT520, AT530, AT540



**GD20**  
Stainless steel  
AT500, AT510, AT520, AT530, AT540, HT400, HT410



**GD10**  
Stainless steel  
AT500, AT510, AT520, AT530, AT540, HT400, HT410



**SD10**  
Stainless steel, black  
AT510, AT520, AT530, AT540, HT400, HT410

A stylish selection of handles is available for all door series.

Please note that not all handles are available on all doors. The pictured handles are not in proportion and this page only shows a selection of handles available. Dimensions are in mm, width x height.

# COLOURS

## INTERNAL WINDOW OPTIONS

### UPVC

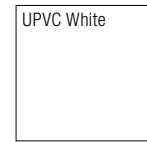

DECOR FOILS	KF 510	KF 520	KF 310	KV 350	KF 410 studio	KF 410 home p.	KF 410 home s.	KF 410 ambiente	KV 440 home p.	KV 440 home s.	KV 440 ambiente	KS 430
Golden Oak			X	X			X	X		X	X	X
Brilliant White			X	X	X	X	X	X	X	X	X	X
Cream White			X	X			X	X		X	X	X
Dark Grey	X	X	X	X	X	X			X			X

### Timber

standard colour <b>SPRUCE</b> , varnished	HF 410/510	HV 450	HF 310	HS 330
FI500	X	X	X	X
FI501	X	X	X	X
FI502	X	X	X	X
FI503	X	X	X	X
FI505	X	X	X	X
FI506			X	X
FI507			X	X

standard colour <b>SPRUCE</b> , varnished	HF 410/510	HV 450	HF 310	HS 330
FI508			X	X
FI509			X	X
FI510	X	X	X	X
standard colour <b>SPRUCE</b> , opaque	HF 410/510	HV 450	HF 310	HS 330
FI916	X	X	X	X
Standard colour <b>LARCH</b> , varnished	HF 410/510	HV 450	HF 310	HS 330
LA600	X	X		X
LA604 oiled	X	X		X

OAK	HF 410/510	HV 450	HF 310	HS 330
EI700	X	X		X
EI701	X	X		X
EI706 oiled	X	X		X
EI707 oiled	X	X		X
ASH	HF 410/510	HV 450	HF 310	HS 330
ES800	X	X		X
WALNUT	HF 410/510	HV 450	HF 310	HS 330
NU400	X	X		X

## EXTERNAL WINDOW OPTIONS

### UPVC

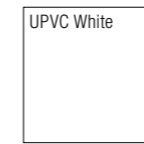

Please note that not every colour is available for every window.

Due to printing and manufacturing technology colour deviations between illustrations and original products may occur.

Your Internorm partner will be happy to show you original colour samples.

### Aluminium cladding

#### STANDARD COLOURS\*



#### hirest-COLOURS\*\*\*



#### HDS COLOURS\*\*



#### STAINLESS STEEL COLOURS

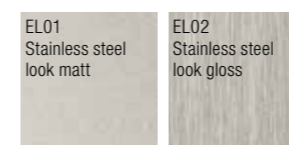

\* **Highly weather-resistant**, except M916 (facade quality).  
 \*\* Intensive colour, variation possible.  
 \*\*\* For surface options **HM** (highly weather-resistant standard colour), **HF** (highly weather-resistant fine structure), **HFM** (highly weather-resistant fine structure metallic), a special highly weather-resistant powder coating is used.



## EXTERNAL VIEW OF DOORS

#### SD COLOURS (ONLY FOR DOORS)

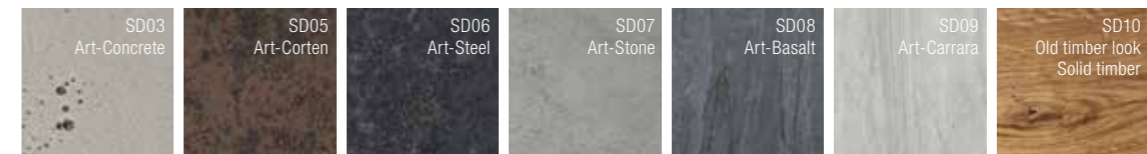



# ECLAZ® THE PREMIUM GLASS COATING

## NOW IN EVERY INTERNORM WINDOW

Unlike artificial light, sunlight does not just create a brighter environment, the colour spectrum also has positive and uplifting biological and psychological effects that can impact the health and wellbeing of humans.

It is therefore important to consider window placement and making the most of the natural light when planning your windows for your home. Slim frames and large glass areas are commonplace in modern architecture, which allows even the darkest corners in a room to appear brighter.

### Improve natural daylight transmission with ECLAZ® premium glass coating

To allow even more natural light to flood your home, Internorm offers the premium ECLAZ® glass coating as standard across its whole product range. ECLAZ® lets up to 10% more daylight to penetrate through the glass.

## THE COMPARISON BRINGS CERTAINTY



### Standard thermal insulating triple glazing

Windows with standard thermal insulating glass keep the rooms warm but reduce light transmission by 25%.

### ECLAZ® thermal insulating glazing from Internorm

Windows with ECLAZ® provide the same insulating properties as other triple glazing but allow noticeably more daylight to enter the interior.

## COMPARED TO CONVENTIONAL GLASS, ECLAZ® OFFERS:



### More light & transparency

- The special coating allows more daylight to enter the interior, therefore making it brighter and friendlier.
- Enjoy a clearer view of the outside. The external reflection or mirror effect is also low and the glass is colour-neutral from the outside.



### Improved health & productivity

- ECLAZ® helps to regulate your inner balance. Blue light from the sun helps to regulate your natural sleep and wake cycle, elevate moods and increase the feeling of well being.
- It also helps to boost alertness, improve productivity and learning.



### Increased happiness & well-being

- Daylight has a balanced light spectrum and regulates the serotonin balance, which is responsible for well-being and life energy. Halogen bulbs, fluorescent tubes and LEDs lack these important light frequencies. ECLAZ® floods the house with daylight.
- 77% more light transmission of triple glazing with ECLAZ® helps to boost health and well-being, especially in the darker autumn and winter months.



### Better energy efficiency & higher cost savings

- Less heat loss: ECLAZ® provides excellent thermal insulation, therefore reducing heating costs.
- Greater energy savings: 60% improvement in solar gain with triple glazing resulting in lower heating costs and higher energy efficiency.



### Get more as standard

- ECLAZ® is fitted as standard in every Internorm window.
- No additional costs. You enjoy the benefits of this premium glass coating without having to pay more.



# SUN AND INSECT PROTECTION

COMBINABLE. INTEGRATED. MANY VARIATIONS.

Sun and insect protection can be combined with the window systems to provide added functionality and to enhance the facade of your house. They can also be integrated into your Smart Home system and conveniently controlled from your smartphone or tablet.

**Integrated blinds:** Sun and privacy protection integrated between glass panes. Choose from Roman, Venetian or black-out Duette blinds, also available with solar powered I-tec shading.

**Internal blinds:** Mounted on the window sash, it can be colour matched to the internal window frame.

**Raffstores:** Optimum control of light and solar gain with adjustable slats. Optional RETROLux louvres. Can be combined with fly screen. Ideal for lift & slide doors.

**Internal Venetian blinds:** Optimum control and guidance of light and warmth through adjustable slats. Can be combined with insect protection.

**External roller/mini-roller shutters:** Delivered separately or fitted to window. Can be combined with fly screen.

**Fly screens:** Available with friction-fit, turn or sliding frames, or pull-down roller mechanism. Can be combined with sun protection options.

**Pleated fly screen:** Space-saving and perfect retrofit solution, suitable for lift & slide doors.

**Window shutters:** Made from aluminium, available in many designs. Can be combined with fly screen.



Raffstores



External roller shutter



Mini exposed roller shutter



Integrated blind



Internal blind



Pull-down fly screen



Turn or fixed frame



Sliding frame



Pleated fly screen



OPTIMA window shutter



# JULIET BALCONY

## EVEN SMALLER ROOMS FEEL MORE SPACIOUS

Balconies and terraces are no longer as popular as they once were and often not an option in city centres for structural reasons. However, large glass areas are integral to modern architecture.

Juliet balconies are the perfect solution for letting more light into a room, providing uninterrupted views, and creating beautiful design features. Made with laminated safety glass and stainless steel trim, Internorm's Juliet balconies are uniquely integrated into the door frame and factory fitted.

*Please ensure that minimum heights comply with Building Regulations to prevent falling.*

Juliet balcony options



Option with laminated safety glass balustrade, including stainless steel trim



Option with round stainless steel rail



Option with square stainless steel rail

# SIDE ENTRANCE DOORS

Side entrance doors serve to close off unused, unheated rooms (e.g. garage, basement storage rooms etc.). Current statistics show that intruders predominantly gain access to a house via side entrances. It is therefore all the more important to consider relevant security features – Internorm offers different security systems upon request.

Side entrance doors are available in timber-aluminium, aluminium and uPVC and offer a wide range of individual design options.



Architect: Spee architecten / Photographer: Ossip van Duivenbo

## TIMBER-ALUMINIUM



**HF 410**



**HF 410**



**HF 310**



**HF 310**

## ALUMINIUM



**AT 500** panel model  
Colour: HM704, handle: HS 10  
Order no.: X0008



**AT 500** Glass model  
Colour: Frame M916, handle: HS10  
Glass: Satinato white  
Order no.: X0009



**AT 500** Glass panel model  
Colour: HM716, handle: HS10  
Glass: Satinato white  
Order no.: X0010



**AT 500** Glass panel model  
Colour: HM735, handle: HS10  
Glass: Satinato white  
Order no.: X0011

## UPVC



**KF 410**



**KF 320**



**KF 310**



**KF 310**

# WARRANTIES

OUR WARRANTIES ENSURE THAT YOU CAN ENJOY YOUR INTERNORM PRODUCTS FOR MANY YEARS TO COME.

As the leading European, internationally active, window brand with 91 years of experience, Internorm is focused on developing innovative, exceptionally high quality and reliable window and door solutions. That's our guarantee.

## Warranty

**10**  
YEARS

- On weather resistance against unnatural change of colour and cracks in surfaces of:
  - white UPVC window and door profiles, except for mitre cracks.
  - inside foil covered UPVC window and door profiles, except for mitre cracks.
  - anodised (a form of metal coating) or powder coated aluminium window and door profiles.
- Against condensation between the sealed panes of insulating glass.
- On the glue connection of glued Georgian/feature bars.
- On the function of the material compound timber, thermal foam and aluminium profiles in timber aluminium composite products when adhering to the Internorm fitting and maintenance guidelines.
- On the function of the glued connection and sealing of the insulating glass panes with window profiles in timber aluminium composite products when adhering to the Internorm fitting and maintenance guidelines.
- Where goods are supplied with marine grade aluminium finish.

## Warranty

**5**  
YEARS

- For PVD coated entrance door handles against corrosion, if no mechanical damage is apparent.
- On weather resistance against unnatural colour changes or cracks in door filling surfaces.

## Warranty

**3**  
YEARS

- On weather resistance against unnatural change of colour and cracks in surfaces of anodised or powder coated aluminium roller shutters, blinds and window shutter profiles.
- On the function of window and door hardware when the Internorm fitting and maintenance guidelines have been followed.
- On weather resistance against unnatural change of colour and cracks in surfaces of UPVC roller shutter profiles.

### WARRANTIES/EXTRACT:

The full version of our warranty information, warranty requirements and how to make a warranty claim, can be found in the Internorm Maintenance, Care and Warranties Manual. This Manual is delivered together with your Internorm products. It is additionally available as a PDF from the Download section of our website, and available from every Internorm 1<sup>st</sup> window partner.

# NATIONAL AND INTERNATIONAL CERTIFICATIONS CONFIRM THE HIGH QUALITY OF OUR PRODUCTS.

Our know-how gives you the security that you receive best service for your money. The most modern production facilities and strictest quality controls ensure quality which is setting standards all over Europe. Awards of independent test institutes from all over Europe are confirming this



Austrian State Emblem



Austrian Quality Label



TUV



Institute for Window Technology  
Rosenheim



RAL Quality Seals



Technical University Graz



MADE IN AUSTRIA



Minergie® Certificate



Austrian Society for  
Environment Simulation



Certificate for products from  
sustainable forestry

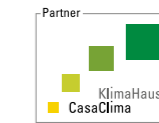

KlimaHaus Certificate



Climate Association  
Town Traun



Energy Globe  
(Project Schiesthaus)



VinylPlus Certificate



EnergieGenie 2016  
(HF 410)



EnergieGenie 2020  
(KF 520)



### IMPRINT

**Publisher:** Internorm International GmbH, Ganglgutstraße 131, A-4050 Traun

**Photos:** Studio Hoflehner, A-4600 Wels | studio46, A-4863 Seewalchen am Attersee | Isa Stein, Studio für Kunst und Architektur, A-4020 Linz | Bernhard Hörtnagl, A-6020 Innsbruck | Internorm International GmbH, A-4050 Traun

**Design and Litho:** Internorm International GmbH, A-4050 Traun

**Print:** Johann Sandler GesmbH & Co KG, 3671 Marbach

Subject to technical changes, layout and printing errors.

Internorm International GmbH is an ARA licence partner: Our licence number is 4477.



# Internorm®

## Austria

Internorm Fenster GmbH

A-1230 Wien · Vorarlberger Allee 27

Tel.: +43 (1) 605 72-0

Email: wien@internorm.com

A-4061 Pasching · Kremstal Straße 5

Tel.: +43 (7229) 770-2440

Email: mittewest@internorm.com

A-6020 Innsbruck · Bleichenweg 14

Tel.: +43 (512) 36 10 48-0

Email: mittewest@internorm.com

A-8502 Lannach · Industriestr. 2

Tel.: +43 (3136) 825 00-0

Email: lannach@internorm.com

## Germany

Internorm-Fenster GmbH

Headquarters Germany

D-93059 Regensburg · Nußbergerstr. 6b

Tel.: +49 (941) 464 04-0

Email: regensburg@internorm.com

## Switzerland

Internorm AG

CH-5502 Hunzenschwil · Römerstrasse 25

Salle d'Exposition Suisse Romande

CH-1030 Bussigny · Rue de l'Industrie 58

window hotline 0848 00 33 33

info-swiss@internorm.com

## France

Internorm Fenêtre SAS

BP 20073 · 10 rue Alcide de Gasperi

Zone Espale

F-68392 SAUSHEIM CEDEX

Tel.: +33 (3) 89 31 68 10

Email: sausheim@internorm.com

## Italy

Internorm Italia S.r.l.

I-38121 Trento (TN) · Via Bolzano, 34

Tel.: +39 (0461) 96 75 11

Email: italia@internorm.com

## Slovenia

Internorm okna d.o.o.

SLO-1000 Ljubljana · Koseška cesta 8

Tel.: +386 (1) 581 92 55

Email: internorm.okna@siol.net

## Czech Republic

Internorm-okno s.r.o.

CZ-190 00 Praha 9 · Ocelářská 7 · Vysočany

Tel.: +420 235 09 04 41-43

Email: internorm@internorm.cz

## Slovakia

Internorm s.r.o.

SK-821 04 Bratislava · Galvániho 15/B

Tel: +421 (2) 436 327 82

Email: office@internorm-okna.sk

## Hungary

Internorm Ablak Kft.

H-2051 Biatorbágy · Sasbérc út 1

Tópark Ingatlankomplexum

Tel.: +36 (23) 786 505

Email: internorm@internorm.hu

## UK / Irland

Internorm Windows UK Ltd

Unit D · Colindale Business Park

2-10 Carlisle Road · London, NW9 0HN

Tel.: +44 (0) 208 205 9991

Email: office@internorm.co.uk